

Tables.

2024



PRODUCT CATALOGUE

XTONE

Tables.

PRODUCT CATALOGUE 2024

XTONE

The possibilities of the porcelain slabs XTONE expand to create new design concepts. Innovative ideas that become reality through the development of finished product solutions, boosting an evolution that has no limits.

Las posibilidades del porcelánico XTONE se expanden para crear nuevos conceptos de diseño. Ideas vanguardistas que consiguen materializarse a través del desarrollo de soluciones de producto acabado, impulsando una evolución que no tiene límite.

Les possibilités du grès cérame XTONE s'élargissent pour créer de nouveaux concepts de design. Des idées avant-gardistes qui réussissent à se matérialiser à travers le développement de solutions de produits finis, poussant une évolution sans limite.



Architecture and design come together to offer a finished product with invaluable longevity, due to the quality of its materials and the timelessness of its designs.
Concepts that come to life with XTONE.

*Arquitectura y diseño se unen para ofrecer un producto acabado de longevidad incalculable, por la calidad de sus materiales y la atemporalidad de sus diseños.
Conceptos que cobran vida con XTONE.*

*Architecture et design s'unissent pour offrir un produit fini d'une longévité incalculable, pour la qualité de ses matériaux et l'intemporalité de ses conceptions.
Des concepts qui prennent vie avec XTONE.*

Tables

Two design lines differentiated by the materials that are part of the composition of its structures. With the XTONE surface as a raw material, a new exclusive, timeless, and elegant product concept emerges.

Dos líneas de diseño diferenciadas por los materiales que participan en la composición de sus estructuras. Con la superficie XTONE como materia prima, surge un nuevo concepto de producto exclusivo, atemporal y elegante.

Deux lignes de conception différenciées par les matériaux impliqués dans la composition de ses structures. Avec la surface XTONE comme matière première, émerge un nouveau concept de produit exclusif, intemporel et élégant.



XT

Whole *Ceramic*

A total of five collections, available in different dimensions, which combine classic geometrical shapes with fine technical details. Exceptional full ceramic designs for both indoors and outdoors.

Un total de cinco colecciones que conjugan formas geométricas clásicas con minuciosos detalles técnicos. Diseños íntegros de cerámica excepcionales tanto para interiores como para exteriores.

Un total de cinq collections, disponibles en différentes dimensions, qui conjuguent des formes géométriques classiques avec des détails techniques. Conception entièrement en céramique idéale pour l'intérieur comme pour l'extérieur.

01
XTC

02
XTS

03
XTR

04
XTF

05
XTO

Mix & match

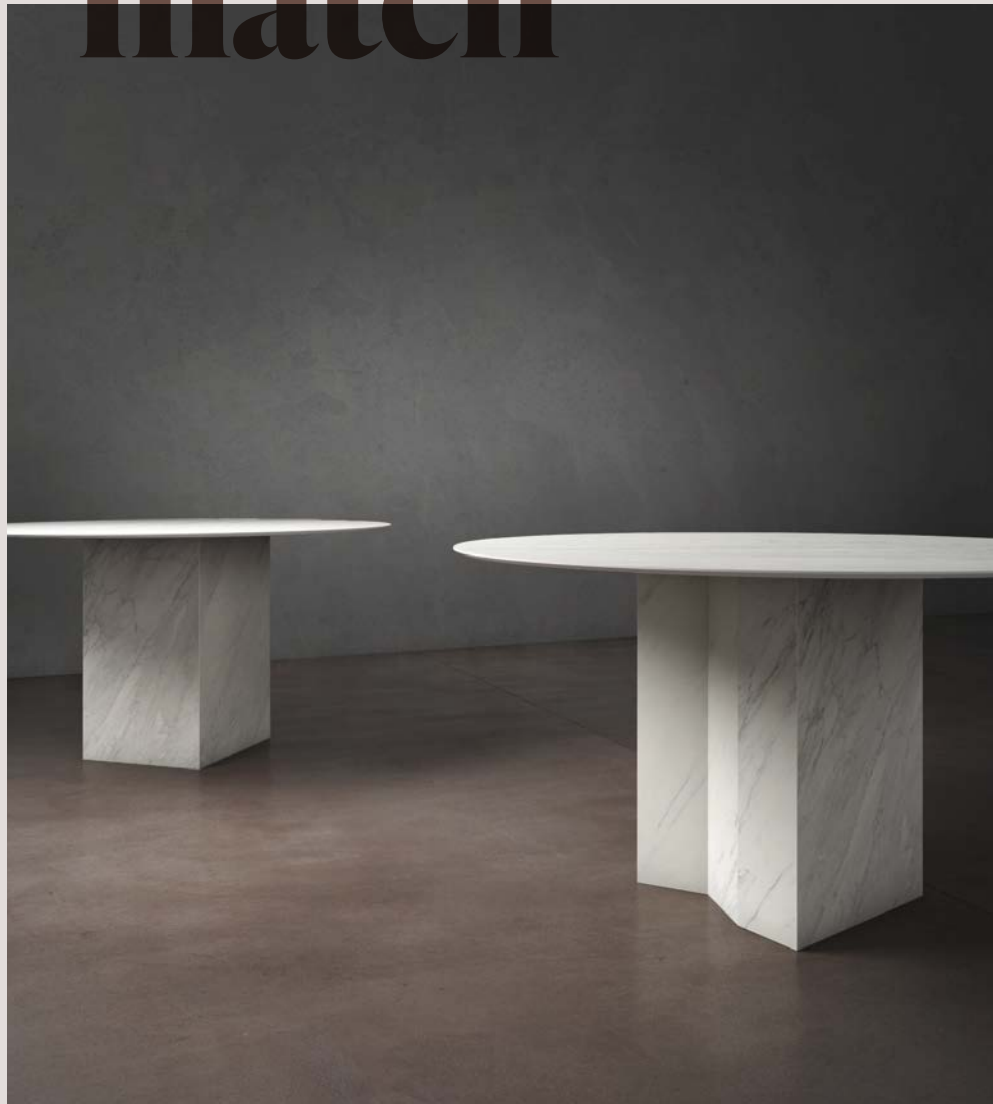

TOP + BOTTOM



XTC

A circular surface that evokes unity,
community. A stroke without beginning
or end sheathed in elegance and harmony.

*Una superficie de forma circular que
tanto evoca la unidad, la comunidad.
Un trazo sin principio ni fin enfundado
en elegancia y armonía.*

*Une surface de forme circulaire qui
évoque l'unité, la communauté.
Un trait sans commencement ni fin
dans l'élégance et l'harmonie.*

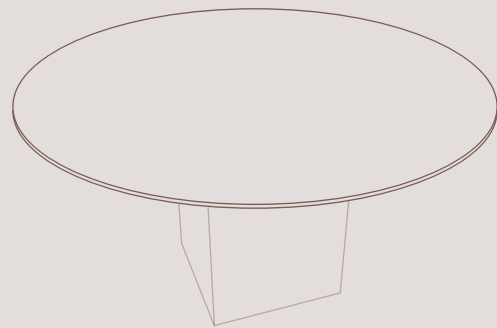

1S

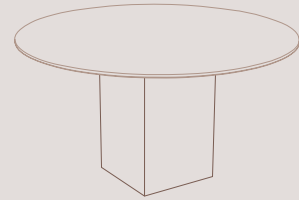

DIMENSIONS DIMENSIONES	NATURE	POLISHED
Ø 120 cm Ø 47 1/4"	G1931	G1931
Ø 140 cm Ø 55 1/8"	G1931	G1931



1A

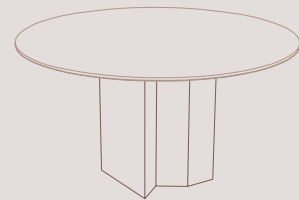

DIMENSIONS DIMENSIONES	NATURE	POLISHED
Ø 120 cm Ø 47 1/4"	G1931	G1931
Ø 140 cm Ø 55 1/8"	G1931	G1931



Height / altura · 75cm / 30"



XTS

The square is the geometry that conveys perfection and balance. Its equal sides and squareness allow us to understand the mathematical stability that characterizes them.

El cuadrado es la geometría que transmite perfección y equilibrio. Sus lados iguales y ángulos rectos permiten comprender la estabilidad matemática que les caracteriza.

Le carré est la géométrie qui transmet la perfection et l'équilibre. Leurs côtés égaux et angles droits permettent de comprendre la stabilité mathématique qui les caractérise.

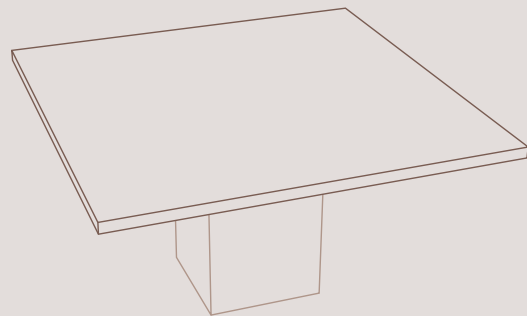

1S

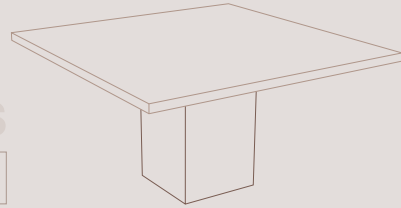

DIMENSIONS DIMENSIONES	NATURE	POLISHED
120 x 120 cm 47 1/4" x 47 1/4"	G1930	G1930
140 x 140 cm 55 1/8" x 55 1/8"	G1931	G1931



1A

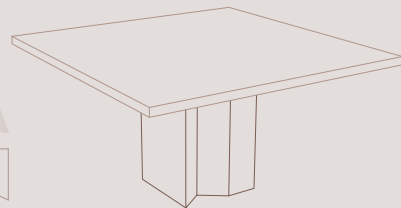

DIMENSIONS DIMENSIONES	NATURE	POLISHED
120 x 120 cm 47 1/4" x 47 1/4"	G1930	G1930
140 x 140 cm 55 1/8" x 55 1/8"	G1931	G1931



Height / altura - 75cm / 30"



XTR

A rectangular plane stands out
for its firmness and stability.
Rational and functional, inviting
to conformity and consonance.

*Un plano rectangular resalta
por su firmeza y estabilidad.
Racional y funcional, invita a la
conformidad y a la consonancia.*

*Un plan rectangulaire se distingue
par sa fermeté et sa stabilité.
Rationnel et fonctionnel, il invite
à la conformité et à l'harmonie.*

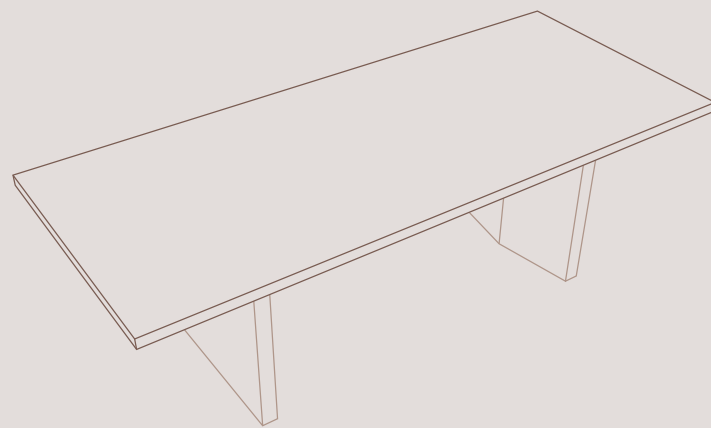

2S

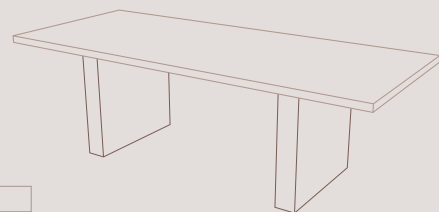

DIMENSIONS DIMENSIONES	NATURE	POLISHED SILK
100 x 240 cm 39 3/8" x 94 1/2"	G1933	G1933
120 x 280 cm 47 1/4" x 110 15/64"	G1936	G1936



4S

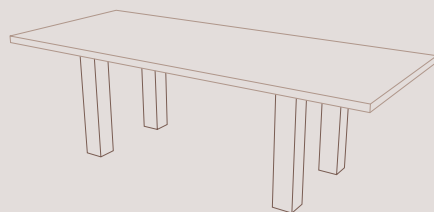

DIMENSIONS DIMENSIONES	NATURE	POLISHED SILK
100 x 240 cm 39 3/8" x 94 1/2"	G1933	G1933
120 x 280 cm 47 1/4" x 110 15/64"	G1936	G1936



2A

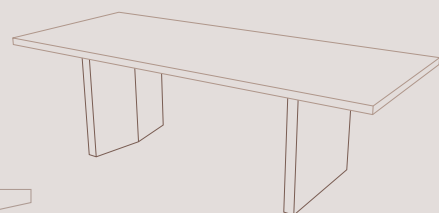

DIMENSIONS DIMENSIONES	NATURE	POLISHED SILK
100 x 240 cm 39 3/8" x 94 1/2"	G1933	G1933
120 x 280 cm 47 1/4" x 110 15/64"	G1936	G1936



4A

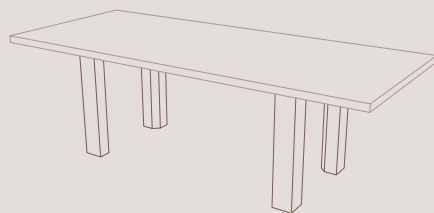

DIMENSIONS DIMENSIONES	NATURE	POLISHED SILK
100 x 240 cm 39 3/8" x 94 1/2"	G1933	G1933
120 x 280 cm 47 1/4" x 110 15/64"	G1936	G1936



Ⓜ REVERSE - 2A / 4A
Allows rotate the position of the leg 180° /
Permite rotar la posición de la pata 180° /
Permet de tourner la position du pied à 180° /

Height / altura · 75 cm / 30"



XTF

Without leaving firmness behind, it brings the smoothness of what is pleasant. Allowing to keep the solidity, intervening in it with its slightly curved corners.

Sin dejar de lado la firmeza, trae de la mano la suavidad de lo agradable. Permite mantener la solidez, interviniendo en ella con sus esquinas ligeramente curvadas.

Sans laisser de côté la fermeté, il apporte de la douceur à l'agréable. Il permet de maintenir la solidité, en intervenant avec ses coins légèrement incurvés.

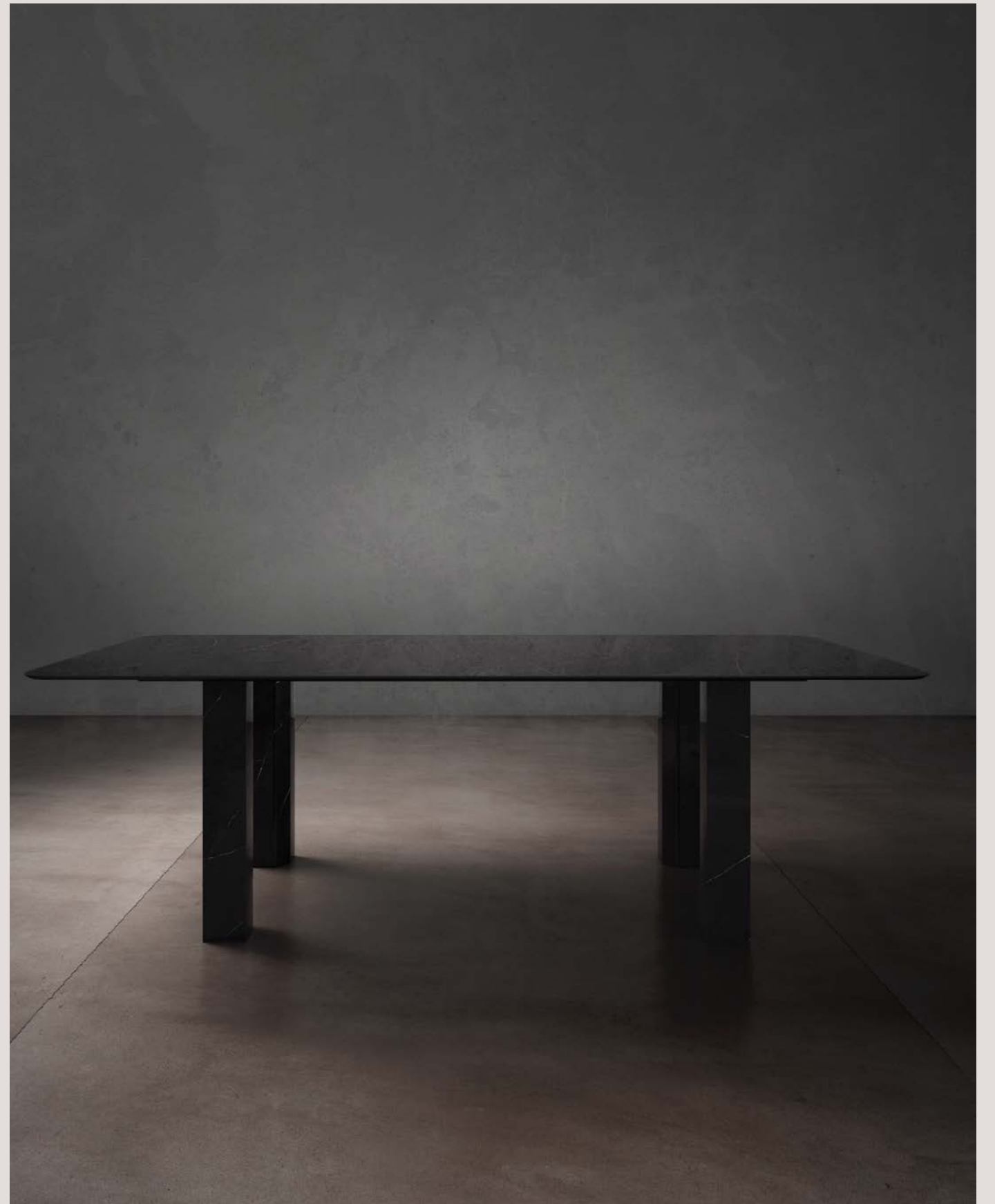
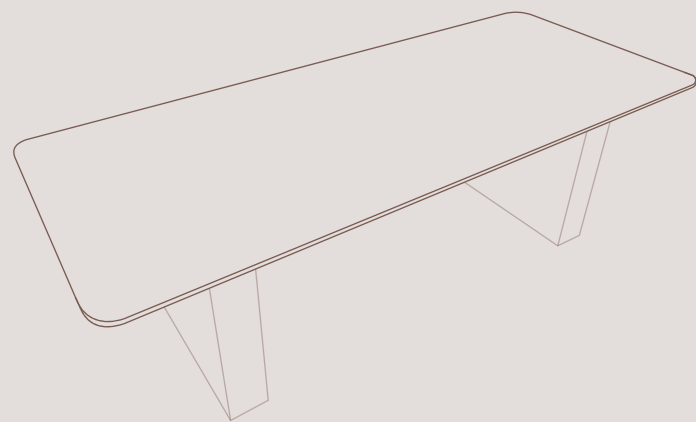

2S

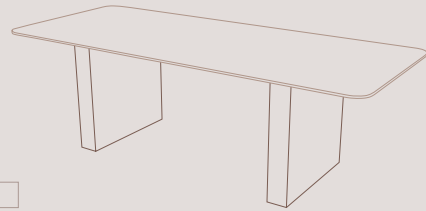

DIMENSIONS DIMENSIONES	NATURE	POLISHED SILK
100 x 240 cm 39 3/8" x 94 1/2"	G1934	G1934
120 x 280 cm 47 1/4" x 110 15/64"	G1936	G1936



4S

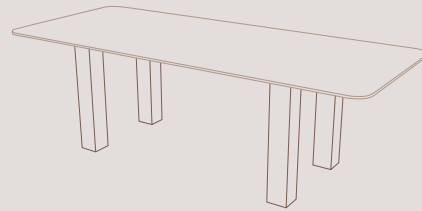

DIMENSIONS DIMENSIONES	NATURE	POLISHED SILK
100 x 240 cm 39 3/8" x 94 1/2"	G1934	G1934
120 x 280 cm 47 1/4" x 110 15/64"	G1936	G1936



2A

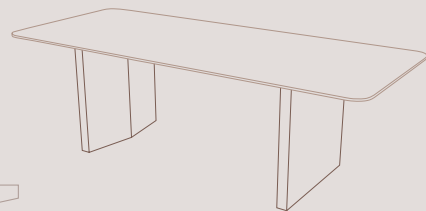

DIMENSIONS DIMENSIONES	NATURE	POLISHED SILK
100 x 240 cm 39 3/8" x 94 1/2"	G1934	G1934
120 x 280 cm 47 1/4" x 110 15/64"	G1936	G1936



4A

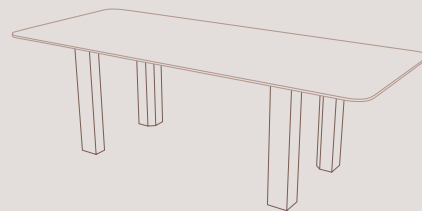

DIMENSIONS DIMENSIONES	NATURE	POLISHED SILK
100 x 240 cm 39 3/8" x 94 1/2"	G1934	G1934
120 x 280 cm 47 1/4" x 110 15/64"	G1936	G1936



Ⓜ REVERSE - 2A / 4A

Allows rotate the position of the leg 180° /
Permite rotar la posición de la pata 180° /
Permet de tourner la position du pied à 180° /

Height / altura · 75 cm / 30"



XTO

A design derivative from elliptical shapes that suggest an oval. The curves allow us to break with normality and routine by entering a world of endless possibilities.

Un diseño derivado de formas elípticas que sugieren un óvalo. Las curvas nos permiten romper con la normalidad y lo sistemático adentrándonos en un mundo de infinitas posibilidades.

Une conception dérivée de formes elliptiques suggérant un ovale. Les courbes nous permettent de rompre avec la normalité et le systématique en nous plongeant dans un monde aux possibilités infinies.

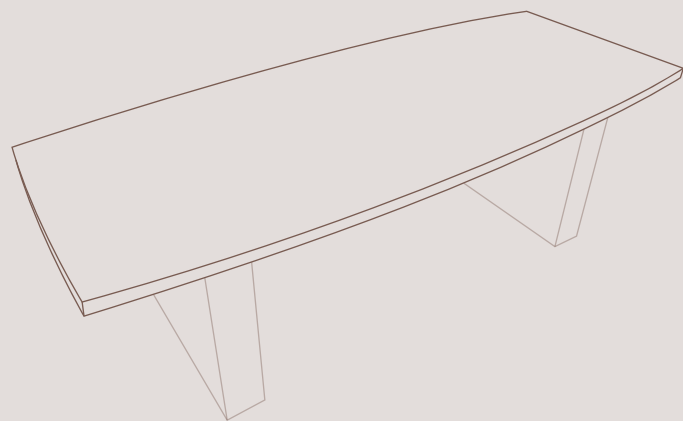

2S

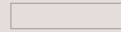
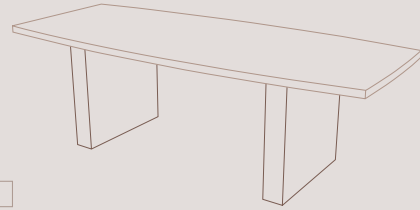

DIMENSIONS DIMENSIONES	NATURE	POLISHED SILK
100 x 240 cm 39 3/8" x 94 1/2"	G1935	G1935
120 x 280 cm 47 1/4" x 110 15/64"	G1937	G1937



4S

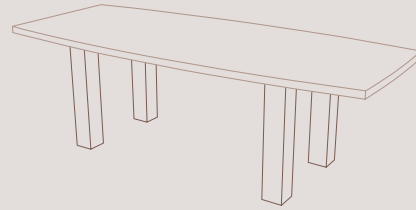

DIMENSIONS DIMENSIONES	NATURE	POLISHED SILK
100 x 240 cm 39 3/8" x 94 1/2"	G1935	G1935
120 x 280 cm 47 1/4" x 110 15/64"	G1937	G1937



2A

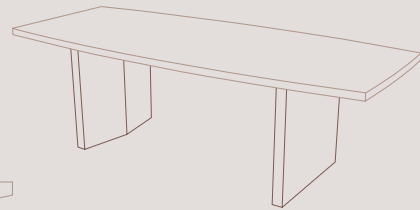

DIMENSIONS DIMENSIONES	NATURE	POLISHED SILK
100 x 240 cm 39 3/8" x 94 1/2"	G1935	G1935
120 x 280 cm 47 1/4" x 110 15/64"	G1937	G1937



4A

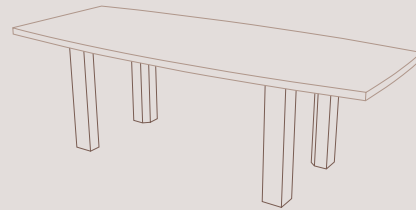

DIMENSIONS DIMENSIONES	NATURE	POLISHED SILK
100 x 240 cm 39 3/8" x 94 1/2"	G1935	G1935
120 x 280 cm 47 1/4" x 110 15/64"	G1937	G1937



Ⓜ REVERSE - 2A / 4A

Allows rotate the position of the leg 180° /
Permite rotar la posición de la pata 180° /
Permet de tourner la position du pied à 180° /

Height / altura · 75 cm / 30"





Steel *Ceramic*

In the wake of the union of multiple qualities that XTONE offers and an avant-garde aluminum structure, a table collection is born and designed to bring a touch of elegance to indoor spaces.

Fruto de la unión de las múltiples cualidades que ofrece XTONE y una estructura aluminica vanguardista, nace una colección de mesa diseñada para aportar un toque de elegancia a los espacios de interior.

Fruit de l'union des multiples qualités offertes par XTONE et d'une structure aluminique avant-gardiste, naît une collection de tables conçues pour apporter une touche d'élégance aux espaces intérieurs.

01
XTL

XTL

Its robust structure in aluminum perfectly complements the recessed top, achieving a one-piece visual design.

Su estructura robusta de aluminio se complementa a la perfección con el sobre encastrado consiguiendo un diseño visual unitario.

Sa structure robuste en aluminium à la perfection par l'enveloppe encastrée pour un design visuel unitaire.





DIMENSIONS DIMENSIONES	STRUCTURE COLOR COLOR ESTRUCTURA	NATURE	POLISHED SILK
66 x 132 cm 26" x 52"	White Black Grey	G1803	G1901 G1902
80 x 132 cm 31 1/2" x 52"	White Black Grey	G1805	G1905 G1908
80 x 160 cm 31 1/2" x 63"	White Black Grey	G1808	G1907 G1910
80 x 180 cm 31 1/2" x 70 7/8"	White Black Grey	G1809	G1915 G1918
100 x 200 cm 39 3/8" x 78 7/8"	White Black Grey	G1810	G1916 G1919
120 x 320 cm 47 1/4" x 126"	White Black Grey	G1815	G1917 G1920

DIMENSIONS DIMENSIONES	STRUCTURE COLOR COLOR ESTRUCTURA	NATURE	POLISHED SILK
120 x 120 cm 47 1/4" x 47 1/4"	White Black Grey	G1806	G1906 G1909

Height / altura · 73,5 cm / 29"

DIMENSIONS DIMENSIONES	STRUCTURE COLOR COLOR ESTRUCTURA	NATURE	POLISHED SILK
66 x 132 cm 26" x 52"	MB White MB Black MB Grey	G1802	G1901 G1902
90 x 90 cm 31 1/2" x 31 1/2"	MB White MB Black MB Grey	G1801	G1903 G1904

Height / altura · 32 cm / 12 5/8"















Available Matches

The vast setting possibilities of different designs of finished products favors its customization through the variety of XTONE collections.

Marbles, concretes, stones, sandstones, woods, and metals available in their different finishes and thicknesses.

Las posibles configuraciones de los distintos diseños de producto acabado favorecen la personalización de su diseño a través de la variedad de colecciones XTONE. Mármoles, cementos, piedras, areniscas, maderas y metales disponibles en sus diferentes acabados y espesores.



Les configurations possibles des différents designs de produits finis favorisent la personnalisation de leur conception à travers la variété des collections XTONE. Marbres, ciments, pierres, grès, bois et métaux disponibles dans leurs différentes finitions et épaisseurs.

	XTC	XTS	XTR	XTF	XTO	XTL
						
						
Aged Clay	●	—	—	●	—	●
Aged Dark	●	—	—	●	—	●
Alpi Verde	●	●	●	●	●	●
Alpinus White	●	●	●	●	●	●
Argos Black	●	●	●	●	●	●
Aria White	●	●	●	●	●	●
Ars Beige	●	●	●	●	●	●
Astana Grey	●	●	●	●	●	●
Bianco Lasa	●	●	●	●	●	●
Blue Roma	●	●	●	●	●	●
Bottega Accero	●	●	●	●	●	●
Bottega Antracita	●	●	●	●	●	●
Bottega Caliza	●	●	●	●	●	●
Calacatta Antico	●	●	●	●	●	●
Calacatta Gold	● (1)	●	●	● (1)	●	● (1)
Calacatta Green	●	●	●	●	●	●
Calatorao	●	●	●	●	●	●
Ewood Camel	●	●	●	●	●	●
Ewood Nut	—	●	●	—	●	—
Ewood White	—	●	●	—	●	—
Fiori Di Bosco	● (1)	●	●	● (1)	●	● (1)
Glem White	●	●	●	●	●	●
Invisible White	●	●	●	●	●	●
Liem Black	●	●	●	●	●	●
Liem Dark	●	●	●	●	●	●
Liem Grey	●	●	●	●	●	●
Montreal White	● (2)	● (2)	● (2)	● (2)	● (2)	● (2)
Moon White	●	●	●	●	●	●
Neda	●	●	●	●	●	●
Nylo Noir	—	●	●	—	●	—
Orobico Dark	●	●	●	●	●	●
Oxide Brown	●	●	●	●	●	●
Paonazzo Biondo	●	●	●	●	●	●
Pietra Sicilia	●	●	●	●	●	●
Taj Mahal	●	●	●	●	●	●
Terre Greige	●	●	●	●	●	●
Tura	●	●	●	●	●	●

(1) Not available in Silk finish / No disponible en acabado Silk / Non disponible en finition Silk
 (2) Not available in Texture finish / No disponible en acabado Texture / Non disponible en finition Texture

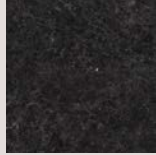
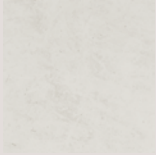
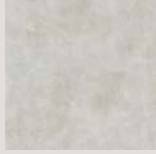
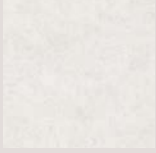

Collections

 Aged Clay Nat.	 Aged Dark Nat.	 Alpi Verde Pol.	 Glem White Nat. / Pol.	 Invisible White Nat. / Pol.	 Liem Black Nat. / Pol.
 Alpinus White Nat. / Tex.	 Argos Black Nat. / Pol.	 Aria White Nat. / Pol.	 Liem Dark Nat. / Pol.	 Liem Grey Nat. / Pol.	 Montreal White Nat. / Pol. / Tex.
 Ars Beige Nat. / Pol.	 Astana Grey Nat. / Pol.	 Bianco Lasa Pol.	 Moon White Nat. / Pol.	 Neda Nat.	 Nylo Noir Pol.
 Blue Roma Pol. / Silk	 Bottega Acero Nat.	 Bottega Antracita Nat.	 Orobico Dark Nat. / Pol.	 Oxide Brown Nat.	 Paonazzo Biondo Pol. / Silk
 Bottega Caliza Nat.	 Calacatta Antico Nat. / Pol.	 Calacatta Gold Nat. / Pol. / Silk	 Pietra Sicilia Tex.	 Taj Mahal Pol. / Silk	 Terre Greige Nat.
 Calacatta Green Pol. / Silk	 Calatorao Nat.	 Ewood Camel Nat.	 Tura Tex.		
 Ewood Nut Nat.	 Ewood White Nat.	 Fiori di Bosco Nat. / Pol. / Silk			



PORCELANOSA, S.A.U. reserves the right to modify and/or discontinue certain models displayed in this catalogue. The colours and finishes of tiles shown in the catalogue may differ slightly from the originals. The settings shown in this catalogue are design proposals for advertising purposes. In real situations in which the tiles are laid, the installation instructions published by PORCELANOSA should be followed. It is agreed that weights, dimensions, capacities, prices, performances, colours and other data contained in catalogues, prospectus, circulars, illustrations, price-lists or other illustrative seller's documents, shall all constitute an approximate guide only.

PORCELANOSA, S.A.U. se reserva el derecho de modificar y/o suprimir ciertos modelos expuestos en este catálogo sin previo aviso. Los colores y acabados de las piezas pueden presentar ligeras diferencias respecto a los originales. Los ambientes que se muestran en este catálogo son sugerencias decorativas de carácter publicitario debiéndose utilizar en la instalación real las instrucciones de colocación editadas por PORCELANOSA. Los pesos, las dimensiones, las capacidades, los precios, los rendimientos, los colores y otros datos que figuren en los catálogos, prospectos, circulares, ilustraciones, listines de precios u otros documentos ilustrativos del vendedor, tienen carácter de indicaciones aproximativas.

PORCELANOSA, S.A.U. se réserve le droit de modifier et supprimer certains modèles exposés dans ce catalogue sans avertir préalablement. Les couleurs et finitions des pièces peuvent présenter légères différences par rapport aux originaux. Les ambiances montrées dans ce catalogue sont des suggestions décoratives de caractère publicitaire, devant utiliser les instructions de pose recommandées par PORCELANOSA pour son installation réelle. Les poids, les dimensions, les capacités, les prix, les rendements, les couleurs et autres données contenues dans les catalogues, brochures, bulletins, des illustrations, liste de prix et d'autres documents illustratifs du vendeur, ont caractère d'indication approximative.

TABLES. PRODUCT CATALOGUE 2024. ED4

© 2024 PORCELANOSA, S.A.U.

Ctra. N-340 Km 56,2
CP 12540 Vila-real, Castellón, ESPAÑA
Tel. (+34) 964 52 52 00 | info@xtone-surface.com
www.xtone-surface.com



PRODUCT CATALOGUE 2024