



GIRECO[®]
Pisos & Baños



Somos una empresa orgullosamente mexicana con más de una década de experiencia en la importación y comercialización de acabados para la construcción, dando servicio al mercado nacional e internacional.

Presentamos nuestra línea de productos que han sido seleccionados cuidadosamente apegados al cumplimiento de estándares de calidad internacional.



ÍNDICE

PISOS

5

WC'S

48

OVALINES

55

TOCADORES

61

GRIFERÍA

67

DATOS TÉCNICOS

77

DESARROLLO DE
OBRAS

87

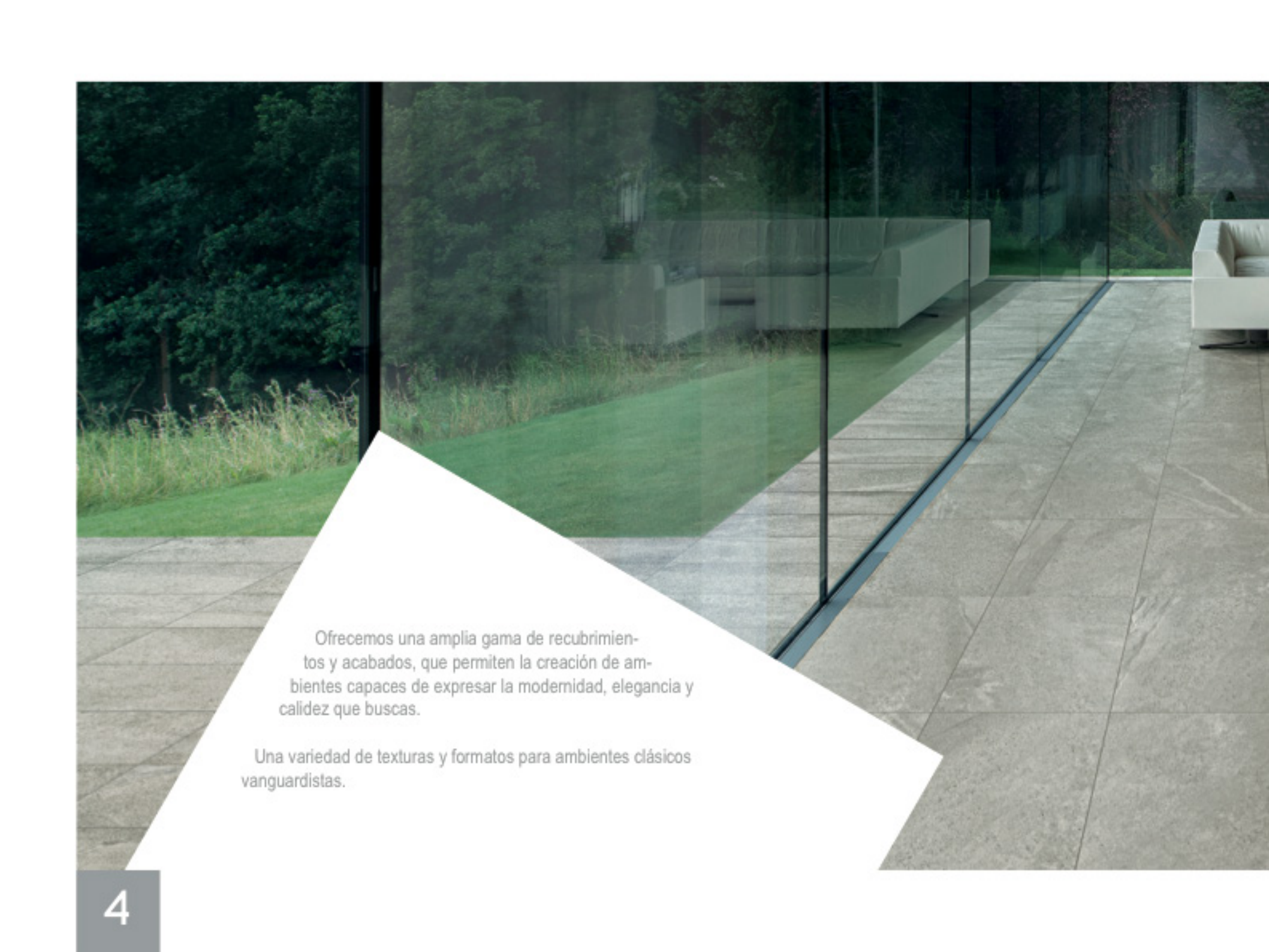

Ofrecemos una amplia gama de recubrimientos y acabados, que permiten la creación de ambientes capaces de expresar la modernidad, elegancia y calidez que buscas.



Una variedad de texturas y formatos para ambientes clásicos vanguardistas.



PISOS





 **MADE**  **IN ITALY**

PISOS
PORCELÁNICOS
ITALIANOS

SERIEBLEND STONE

MADE IN ITALY

Piso porcelánico
esmaltado y rectificado en impresión **INKJET**

Medida: 45 x 90 cm

Pzas/ caja: 3

Cubre: 1.215 m² / caja

Peso/ caja: 27 kg

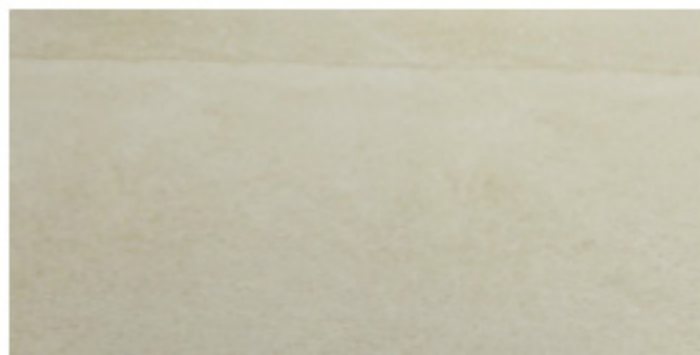

Ivory
3PBSI84I



Pepper
3PBSP85I



SERIE BLEND STONE

SERIE **SIERRA**  
MADE IN ITALY

Piso porcelánico
esmaltado y rectificado en impresión **INKJET**

Medida: 16 x 100 cm

Pzas/ caja: 4

Cubre: 0.66 m² / caja

Peso/ caja: 16 kg



Sierra Brown
3PSB74I



Sierra Grigio
3PSG73I



SERIE **SIERRA**

SERIEATHENA

Piso porcelánico
esmaltado y rectificado en impresión **INKJET**

Medida: 50 x 100 cm

Pzas/ caja: 3

Cubre: 1.50 m² / caja



Peso/ caja: 39.5 kg



Pearl Lappato
3PAPL106I



Cliff Lappato
3PACL105I

 
MADE IN ITALY



SERIEATHENA





PISOS

PORCELÁNICO

ESMALTADOS

SERIE LEGNO

Piso porcelánico
esmaltado y rectificado en impresión **INKJET**

Medida: 90 x 15 cm

Pzas/ caja: 8

Cubre: 1.08 m² / caja

Peso/ caja: 16 kg



Arica
3PA89I



Tarapacá
3PT90I



Valdivia
3PV91I



Viña del Mar
3PVM100I

Medida: 100 x 20 cm

Pzas/ caja: 5

Cubre: 1 m² / caja

Acabado: Esmaltado/ Rectificado

Peso/ caja: 29 kg



SERIE **LEGNO**



Chelsea
3PCH101I



Tribeca
3PTR103I

SERIE QUARTIERE

Piso porcelánico
esmaltado y rectificado en impresión **INKJET**
Medida: 60 x 60 cm
Pzas/ caja: 4
Cubre: 1.44 m² / caja
Peso/ caja: 32 kg



Nolita
3PNO102I



Soho
3PSO104I



SERIE QUARTIERE

SERIE TREVISO

Piso porcelánico
esmaltado y rectificado en impresión **INKJET**
Medida: 60 x 60 cm
Pzas/ caja: 4
Cubre: 1.44 m² / caja
Peso/ caja: 32 kg



Bianco
3PTB82I



Grigio
3PTG83I



SERIETREVISO



Beige
3PFB55I

SERIEFORNO

Piso porcelánico
esmaltado y rectificado
Medida: 60 x 60 cm
Pzas/ caja: 4
Cubre: 1.44 m² / caja
Peso/ caja: 32 kg



Slate
3PFS57I



Rock
3PFR56I



SERIE **FORNO**

SERIE POTENZA

Piso porcelánico
esmaltado y rectificado
Medida: 60 x 60 cm
Pzas/ caja: 4
Cubre: 1.44 m² / caja
Peso/ caja: 32 kg

Grey
3PPG60I



Grey Light
3PPGL80I



Cream
3PPC58I

Monza Cream
3PMC62I

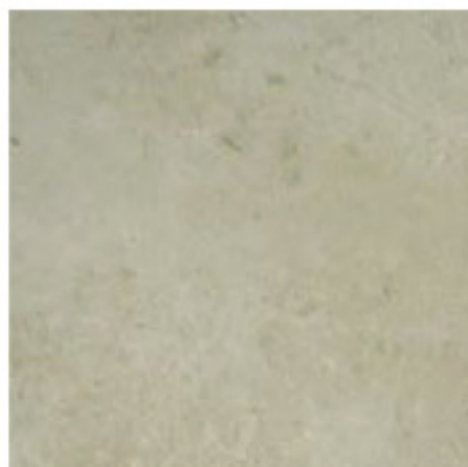

Moca
3PPM61I



Beige
3PPB59I





SERIE POTENZA

SERIE CEMENTO

Piso porcelánico
esmaltado y rectificado
Medida: 60 x 60 cm
Pzas/ caja: 4
Cubre: 1.44 m² / caja
Peso/ caja: 32 kg



Pamplona
3PP66I

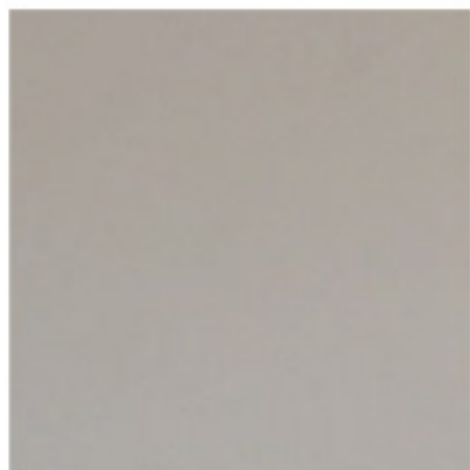

Cantabria
3PC92I



Tenerife
3PT93I



SERIE CEMENTO



Navarra
3PN94I



Tarragona
3PT71I

SERIE PASTA BLANCA

Medida: 60 x 60 cm

Pzas/ caja: 4

Cubre: 1.44 m² / caja

Acabado: Esmaltado/ Rectificado

Peso/ caja: 29 kg



Lugo
3PL95I



Málaga
3PM68I



PISOS
PASTA BLANCA

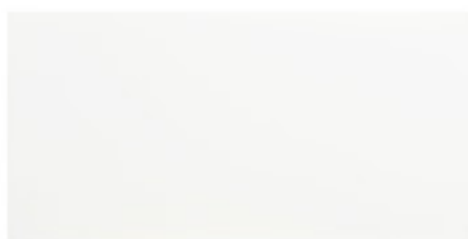

Lavan Mate
3MCBLM87I

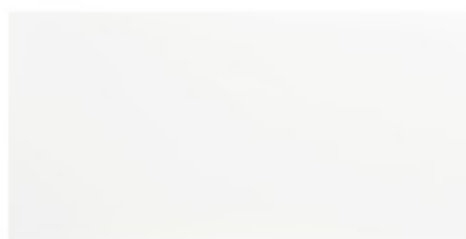

Lavan Pulido
3MCBLP88I

SERIEMURO

Muro pasta blanca
mate/brillo rectificado
Medida: 30 x 60 cm
Pzas/ caja: 8
Cubre: 1.44 m² / caja
Peso/ caja: 21 kg

SERIE30 X 90

Muro pasta blanca
brillo/relieve rectificado
Medida: 30 x 90 cm
Pzas/ caja: 5
Cubre: 1.35 m² / caja
Peso/ caja: 23 kg

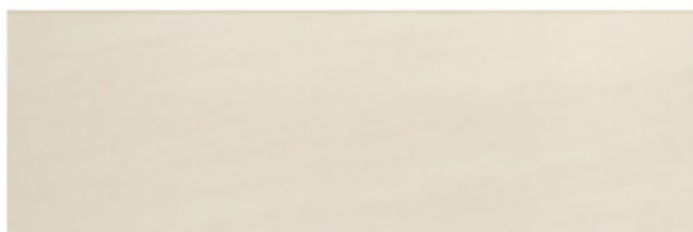

Badajoz
3MBA98I



Jerez
3MJE99I



Celta
3MCE96I



Cáceres
3MCA97I



SERIEMURO





PISOS
PORCELÁNICOS
PULIDOS CON NANOMÉTRICO



Punta del Este
3PE34I

SERIE60 X 60

Piso porcelánico
pulido y rectificado c/ nanométrico
Medida: 60 x 60 cm
Pzas/ caja: 4
Cubre: 1.44 m² / caja
Peso/ caja: 32 kg



Cadaques
3PC29I



Murcia
3PM09I



SERIE **60** X **60**

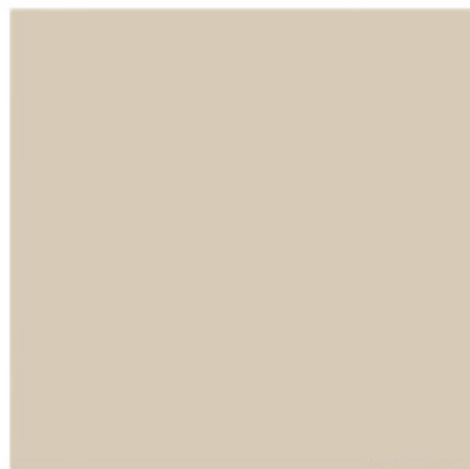

Arequipa
3PA56I



Menorca
3PM63I



Ibiza
3PI62I

SERIE 60 X 60

Piso porcelánico
pulido y rectificado c/ nanométrico
Medida: 60 x 60 cm
Pzas/ caja: 4
Cubre: 1.44 m² / caja
Peso/ caja: 32 kg



SERIE 60 X 60

Galicia
3PG57I



SERIEMONOCOLOR

Piso porcelánico
pulido y rectificado c/ nanométrico
Medida: 60 x 60 cm
Pzas/ caja: 4
Cubre: 1.44 m² / caja
Peso/ caja: 32 kg

Cádiz
3PC52I

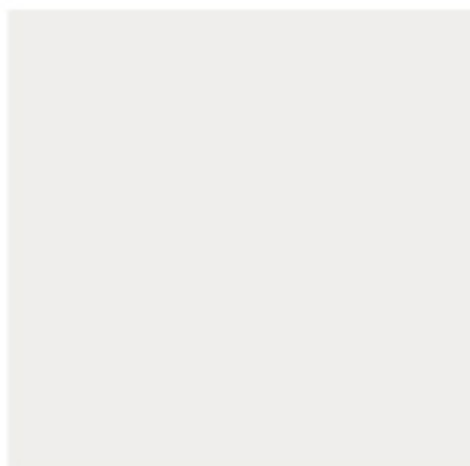

Valparaíso
3PV86I

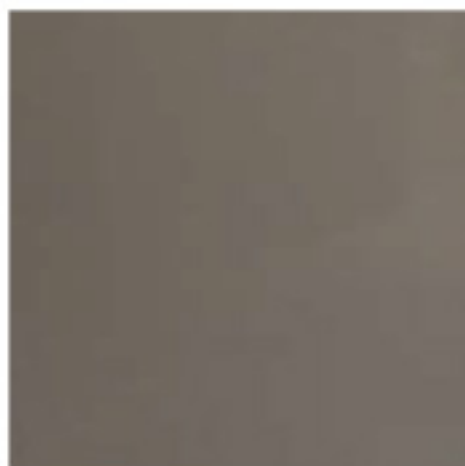



SERIE MONOCOLOR

SERIEDOUBLE CARGA

Piso porcelánico
pulido y rectificado c/ nanométrico

Medida: 60 x 60 cm

Pzas/ caja: 4

Cubre: 1.44 m² / caja

Peso/ caja: 32 kg

*Medida: 80 x 80 cm

Pzas/ caja: 3

Cubre: 1.92 m² / caja

Peso/ caja: 46 kg

Impresión en **NKJET



Bogotá
3PB15I



**Barranquilla
3PB86I



Quito
3PQ17I



Cali
3PC58I

*Cali 80 x 80
3PC81I



SERIE DOBLE CARGA

Caracas
3PC60I



Lima
3PL59I



SERIE 80 X 80

Piso porcelánico
pulido y rectificado c/ nanométrico
Medida: 80 x 80 cm
Pzas/ caja: 3
Cubre: 1.92 m² / caja
Peso/ caja: 46 kg



SERIE 80 X 80

SERIEMARMI

Piso porcelánico esmaltado
pulido y rectificado en impresión **INKJET**

Medida: 60 x 90 cm

Pzas/ caja: 3

Cubre: 1.62 m² / caja

Peso/ caja: 42 kg



León
3PL105I

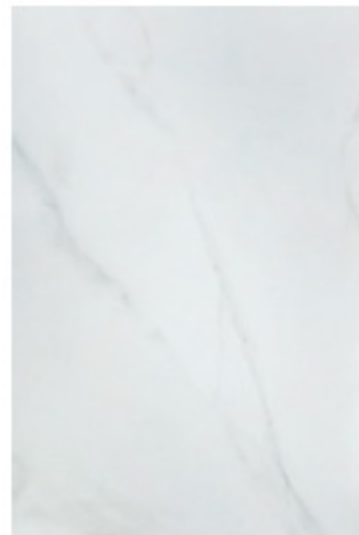

Carrara
3PC93I



Galala
3PG58I

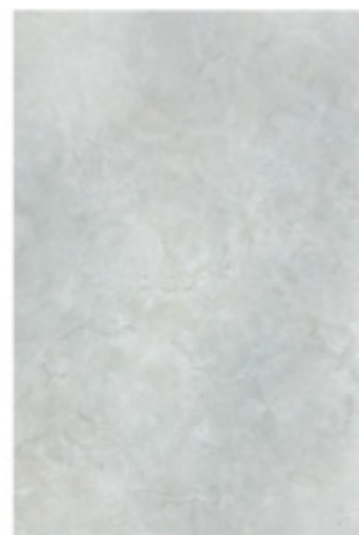

Santo Tomás
3PST7I



SERIEMARMI

DECORADO

Medida: 30 x 30 cm
Pzas/ caja: 11 mallas

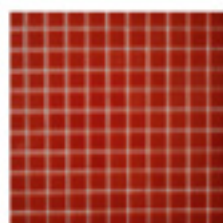

Cristal Red
5CRISRED



Cristal Beige
5CRISBEIGE

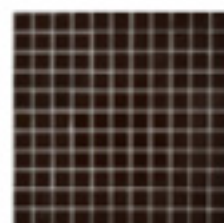

Cristal Brown
5CRISBRO

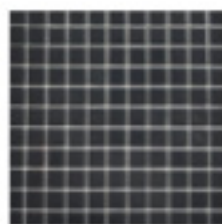

Cristal Grey
5CRISGREY

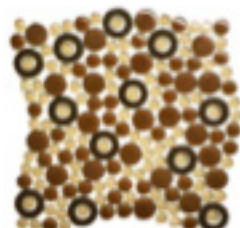

Circle Brown
5CIRBRO

DECORADO

Medida: 30 x 30 cm
Pzas/ caja: 11 mallas

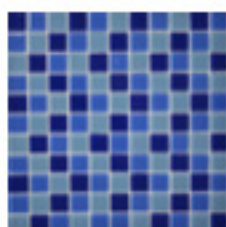

Mix Azul Mar
5MIXAZUMAR

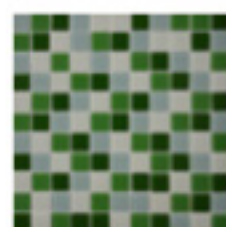

Mix Verde
5MIXVER

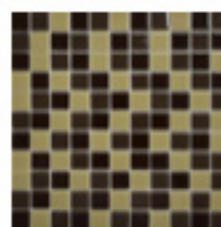

Mix Beige
5MIXBEIGE

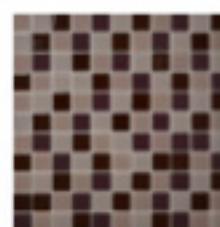

Mix Pink
5MIXPINK

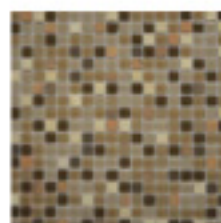

Cadiz GL 10
5CADGL10

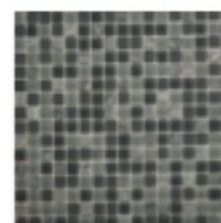

Cadiz GL 16
5CADGL16



WC'S





Dubai Premium
6MWC6I

Ancho: 39 cm

Alto: 74.5 cm

Profundidad: 70 cm

NOM-009-CONAGUA-2001



Grado
ecológico

- + Dual flush
- + Sistema Slow Down
- + Trampa Esmaltada



**** Dubai**

Blanco - 6MWC1

Marfil - 6MWC2I

Ancho: 39 cm

Alto: 63.5 cm

Profundidad: 73 cm

NOM-009-CONAGUA-2001



Grado
ecológico



WC'S



*** Dubai Cuadrato**

6MWC14I

Ancho: 35 cm

Alto: 76 cm

Profundidad: 63 cm

NOM-009-CONAGUA-2001



Ciclo
ecológico

- + Dual flush
- + Sistema Slow Down
- + Trampa Esmaltada



Dubai Plus

Blanco - CMWC5I

Marfil - 6MWC13I

Ancho: 41 cm

Alto: 65.5 cm

Profundidad: 73 cm

NOM-009-CONAGUA-2001



Delhi
6MWC17I
Ancho: 41 cm
Alto: 67.2 cm
Profundidad: 72.2 cm
NOM-009-CONAGUA-2001

- + Dual flush
- + Sistema Slow Down
- + Trampa Esmaltada



Estambul
6MWC16I
Ancho: 42.3 cm
Alto: 73.2 cm
Profundidad: 71 cm
NOM-009-CONAGUA-2001





OVALINES



7OV01I

Ancho: 57.5 cm
Alto: 14 cm
Profundidad: 46.5 cm



7OV03I

Diámetro: 40 cm
Alto: 15.5 cm



7OV05I

Diámetro: 40.5 cm
Alto: 16 cm



7OV06I

Ancho: 48 cm
Alto: 11 cm
Profundidad: 48 cm



7OV11I

Diámetro: 42 cm
Alto: 15.5 cm



7OV12I

Ancho: 51.5 cm
Alto: 15.5 cm
Profundidad: 43 cm



7OVB16I Blanco
7OVM16I Marfil

Diámetro: 41.5 cm
Alto: 16.5 cm



7OVB17I Blanco
7OVM17I Marfil

Ancho: 38 cm
Alto: 13.5 cm
Profundidad: 37 cm



7OVB18I Blanco
7OVM18I Marfil

Ancho: 52 cm
Alto: 111 cm
Profundidad: 18 cm



OVALINES
CERÁMICOS

ÓNIX



7OV200
Diámetro: 40.5 cm
Alto: 15 cm



7OV260
Ancho: 67 cm
Alto: 10 cm
Profundidad: 47 cm

MÁRMOL



7OV24M
Ancho: 40.5 cm
Alto: 9 cm
Profundidad: 40 cm



7OV27M
Diámetro: 40.5 cm
Alto: 15 cm



7OV23M
Ancho: 50 cm
Alto: 10 cm
Profundidad: 35 cm



OVALINES
ÓNIX / MÁRMOL





TOCADORES

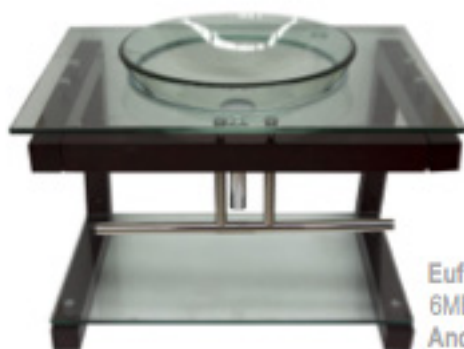

Eufrates
6MBEUF1
Ancho: 70 cm
Alto: 50 cm
Profundidad: 50 cm
Ovalín: 40 cm de diámetro



Amazonas
6MBAMA1
Ancho: 87 cm
Alto: 44 cm
Profundidad: 47 cm



Obi
6MBOBI
Ancho: 98 cm
Alto: 86 cm
Profundidad: 45 cm



Ródano
6MBRODI
Ancho: 81 cm
Alto: 90.5 cm
Profundidad: 52 cm



Guadalquivir
6MBGUA1
Ancho: 69 cm
Alto: 76 cm
Profundidad: 51 cm



TOCADORES



Mississippi
14MD3OD301
Ancho: 75.5 cm
Alto: 63.5 cm
Profundidad: 46 cm



Missouri
14MD4OD401
Ancho: 76 cm
Alto: 51 cm
Profundidad: 46.5 cm



Colorado
14MD2OD201
Ancho: 100 cm
Alto: 45 cm
Profundidad: 48 cm



TOCADORES



A close-up photograph of a modern, polished metal faucet. The faucet has a sleek, curved design with a central spout. The background is a blurred, textured surface, possibly a wall or countertop. A large, semi-transparent, dark red diamond shape is overlaid on the right side of the image, containing the word "GRIFERÍA" in white, uppercase letters.

GRIFERÍA



Monomando Alto
14MABC2I



Monomando Corto
14MCBC1I



Mon. P Regadera
14MRBC3I



Regadera
14RBC4I



Regadera
14RBC9I



Gancho
14GBC5I



Portapapel
14PPBC8I



Toallero Argolla
14TABC6I



Toallero Barra
14TBBC7I

SERIE BREZZA CUADRATA



Monomando Corto
14MCBTE11



Monomando Corto
14MCBT11



Monomando alto
14MABTE12I



Monomando alto
14MABT2I



Mon. A la pared
14MPBT3I



Mon. P Regadera
14MRBT4I



Regadera
14RBT5I



Regadera
14RBT10I



Gancho
14GBT6I



Toallero Argolla
14TABT7I



Toallero Barra
14TBBT8I



Portapapel
14PPBT9I

SERIE BREZZA TONDA



Monomando alto
12MAC3I



Monomando corto
12MCC2I



Monomando a la pared
12MPC0I



Monomando
de regadera
con desviador
12MRD8I



Monomando
de regadera
sin desviador
12MRS6I



Regadera
12RC10I



Brazo para regadera
Medida: 41 cm
12BR12I



Gancho
12GC17I



Portapapel
12PP16I



Toallero corto
12TC15I



Toallero de barra
12TB14I

SERIE CUADRATA PLUS



Monomando alto
12MAR5I



Monomando corto
12MCR4I



Monomando
a la pared
12MPR1I



Monomando
de regadera
con desviador
12MRD9I



Monomando
de regadera
sin desviador
12MRS7I



Regadera
12RR11I



Brazo de regadera
12BR13I
Medida: 41 cm



Gancho
12GT21I

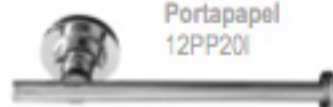

Portapapel
12PP20I



Toallero corto
12TC19I



Toallero de barra
12TB18I

SERIE TONDA PLUS



Recomendaciones de instalación, medidas
y especificaciones de nuestros productos











DATOS TÉCNICOS

Recomendaciones de instalación para pisos Porcelánico









- Los productos cerámicos presentan matices dentro de un mismo tono, se recomienda mezclar el contenido de varias cajas antes de instalar
- Utilice un adhesivo para recubrimientos de baja absorción o para porcelánicos
- Use una llana dentada de 12x12 mm para lograr un espesor de adhesivo adecuado para productos de estas características.
- Distribuya el adhesivo en una sola dirección y de manera uniforme.
- Se recomienda una boquilla mínima de 2 mm de color similar al producto, aplicándola sólo sobre la junta y no sobre toda la superficie de la pieza; removiendo los excesos.
- Es importante dejar el piso protegido con las cajas extendidas mientras la obra concluye.
- Cuando la boquilla haya secado asegúrese de remover la cera protectora, utilizando un limpiador neutro y agua limpia o el mismo adhesivo y talle con una esponja. (Pisos Pulido)
- Limpie periódicamente con agua y un limpiador neutro.
- No utilice productos abrasivos como los alcalinos, ácidos, pulidoras o cepillos de cerda de fierro.
- Para cualquier duda contáctese a su distribuidor.

FICHA TÉCNICA DE PISOS ESMALTADOS

	Características técnicas	Normas	Datos
	Resistencia a la abrasión	ISO 10545-7	Resistente
	Absorción de agua	ISO 10545-3	$\leq 0.5\%$
	Resistencia a doblar	ISO 10545-4	50Nmm = 509kg/cm ²
	Resistencia al cuarteado	ISO 10545-11	Resistente
	Resistencia al ataque químico	ISO 10545-13	min. GB DE GLA, GLB A GLC Método disponible
	Resistencia a las manchas	ISO 10545-14	min.3
	Dimensión y aspecto	ISO 10545-2	Conforme
	Resistencia a heladas	ISO 10545-12	Resistente

Formato	m ² / caja	Pzas. / caja	kg / caja	Cajas / pallet	m ² / pallet	kg / pallet
16x100 cm	0.66	4	15.93	54	35.64	860.2
30x60 cm	0.90	5	20.02	48	43.20	960.9
60x60 cm	1.08	3	25.08	32	34.56	802.5
50x100 cm	1.50	3	34.27	30	45	1028

FICHA TÉCNICA DE PISOS PULIDOS

	Características técnicas	Normas	Datos
	Resistencia a la abrasión	EN 102	$\leq 0.5\%$
	Absorción de agua	EN 99	$\leq 0.5\%$
	Resistencia a doblar	EN 100	50Nmm
	Resistencia al cuarteado	EN 101	$\leq 0.8\%$
	Resistencia al ataque químico	EN 106	No se afecta
	Resistencia al choque térmico		Resistente
	Dilatación térmica lineal		$6 \times 10^{-6}K^{-1}$
	Dimensión y aspecto	EN 98	Conforme
	Resistencia a heladas	EN 202	Resistente

Formato	m ² / caja	Pzas. / caja	kg / caja	Cajas / pallet	m ² / pallet	kg / pallet
30.2x60.4 cm	1.650	9	28.12	48	79.20	1363
30.7x61.0 cm	1.690	9	28.12	48	81.12	1363

Características técnicas	Normas	Valores	Datos Porcelánico Pulido	Datos Doble Carga
Descuadre (%)	10.545-2	+ - 0.60	+ - 0.20	+ - 0.20
Grosor (%)	10.545-2	Nominal + - 5	Nominal + - 0.30	Nominal + - 0.30
Curvatura (%)	10.545-2	+ - 0.50	+ - 0.40	+ - 0.40
Resistencia a las manchas	10.545-14	Método de ensayo disponible	Mínimo clase 3	Mínimo clase 3
Absorción al agua	EN 99	+ - 3%	+ - 0.5%	+ - 0.3%
Resistencia a la flexión	EN 100	+ - 27 N/mm ²	+ - 35 N/mm ²	+ - 45 N/mm ²
Resistencia a la abrasión	EN 102	+ - 205 mm ³	+ - 185 mm ³	+ - 150 mm ³
Resistencia al choque térmico	EN 104	145°C/-15°C	Resiste	Resiste
Resistencia a heladas	EN 202		Resiste	Resiste
Estabilidad de contraste a la luz	DIN51094		OK	OK

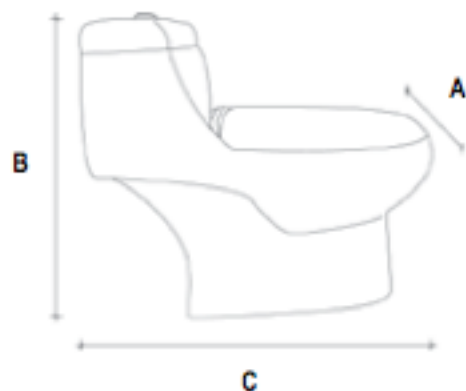

Dubai Plus
Blanco - 6MWC5
A = 41 cm
B = 65.5 cm
C = 73 cm
Peso: 43 Kg

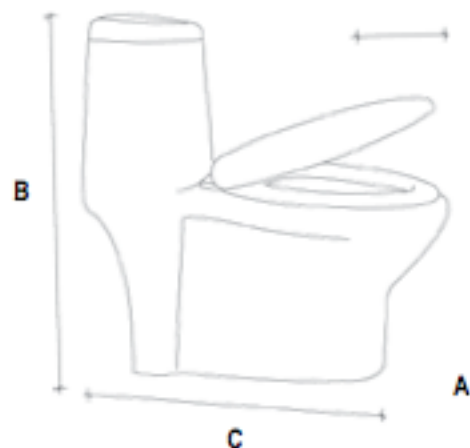

****Dubai Premium**
6MWC6
A = 39 cm
B = 74.5 cm
C = 70 cm
Peso: 38 Kg

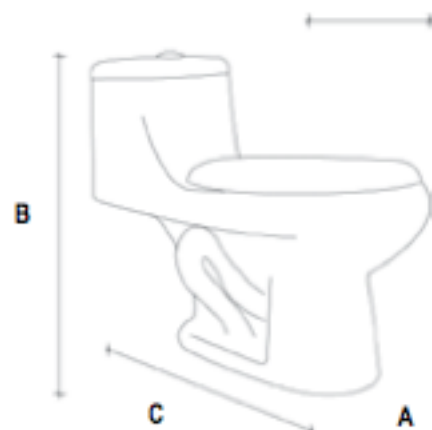

*** Dubai**
Blanco - 6MWC1
A = 39 cm
B = 63.5 cm
C = 73 cm
Peso: 34.30 Kg

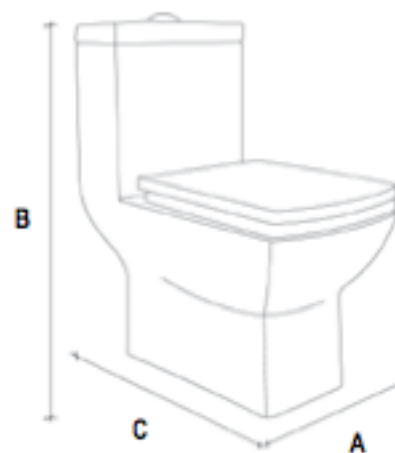

***** Dubai Cuadrato**
6MWC14
***A = 35 cm
B = 76 cm
C = 63 cm
Peso: 40.5 Kg

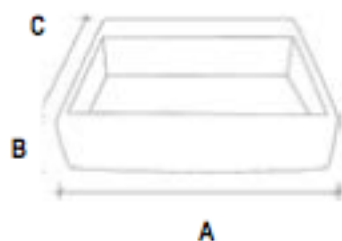

70V01I
A = 57.5 cm
B = 14 cm
C = 46.5 cm

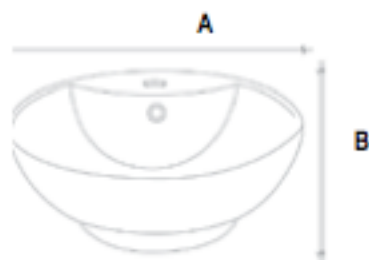

70V03I
A = 40 cm
B = 15.5 cm

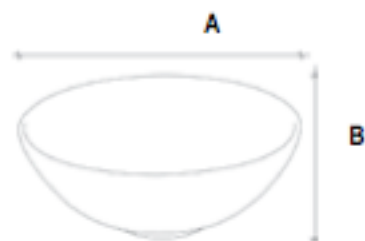

70V05I
A = 40.5 cm
B = 16 cm

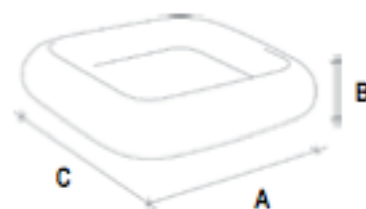

70V06I
A = 48 cm
B = 11 cm
C = 48 cm



70VB18I
A = 52 cm
B = 111 cm
C = 18 cm



70V11I
A = 42 cm
B = 15.5 cm



70V12I
A = 51.5 cm
B = 15.5 cm
C = 43 cm

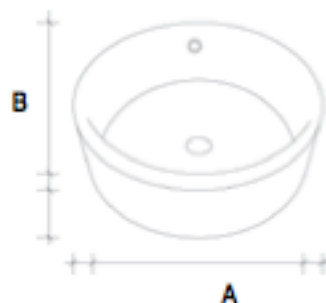

70VB16I Blanco
70VM16I Marfil
A = 41.5 cm
B = 16.5 cm

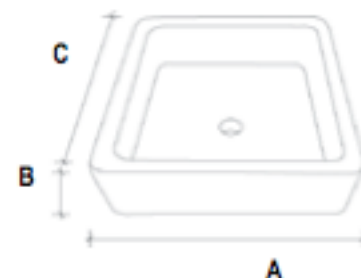

70VB17I Blanco
70VM17I Marfil
A = 38 cm
B = 13.5 cm
C = 37 cm

ÓNIX



70V200

A = 40.5 cm

B = 15 cm



70V260

A = 67 cm

B = 47 cm

C = 10 cm

MÁRMOL

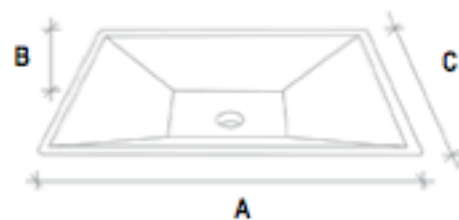

70V23M

A = 50 cm

B = 10 cm

C = 35 cm



70V27M

A = 40.5 cm

B = 15 cm

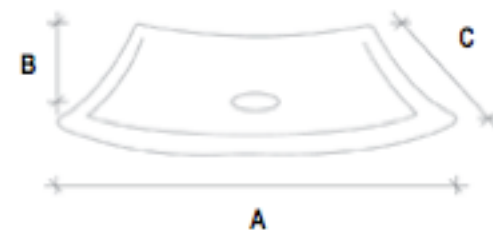

70V24M

A = 40.5 cm

B = 9 cm

C = 40 cm

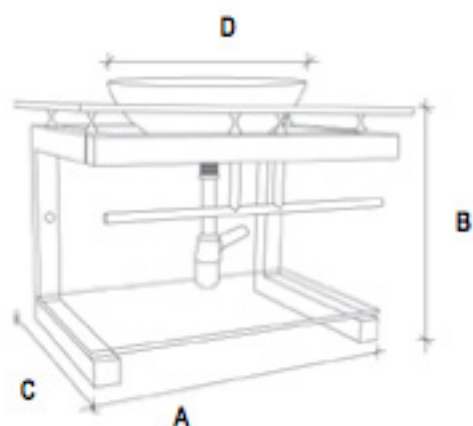

Eufrates
6MBEUFI
A = 70 cm
B = 50 cm
C = 50 cm
D = 40 cm

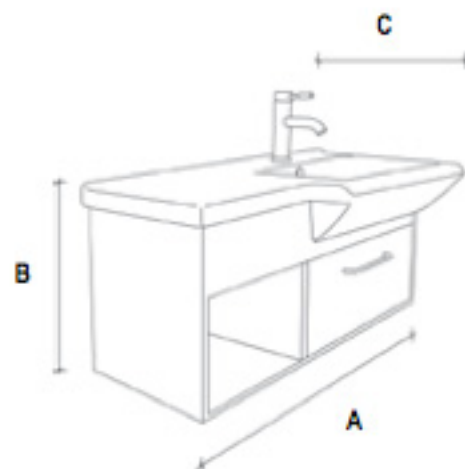

Amazonas
6MBAMA
A = 87 cm
B = 44 cm
C = 47 cm

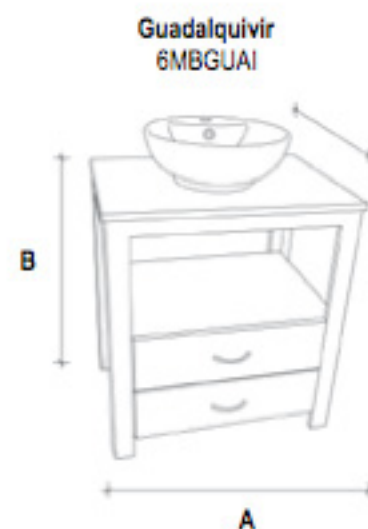

Guadalquivir
6MBGUA
A = 69 cm
B = 76 cm
C = 51 cm

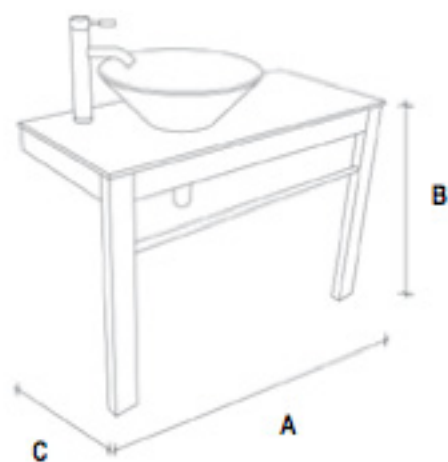

Obi
6MBOBI
A = 98 cm
B = 86 cm
C = 45 cm

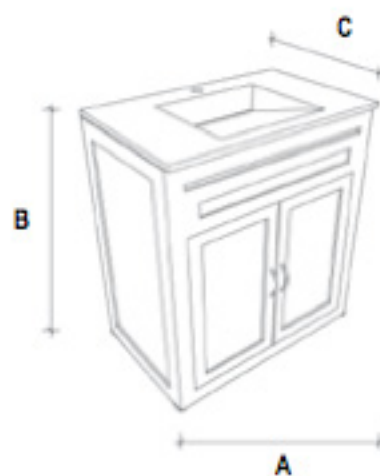

Ródano
6MBRODI
A = 81 cm
B = 90.5 cm
C = 52 cm





DESARROLLO DE OBRAS





ALTEZZA SAN ÁNGEL



GRUPO SADASI



GRUPO CARSO



CASAS ARA

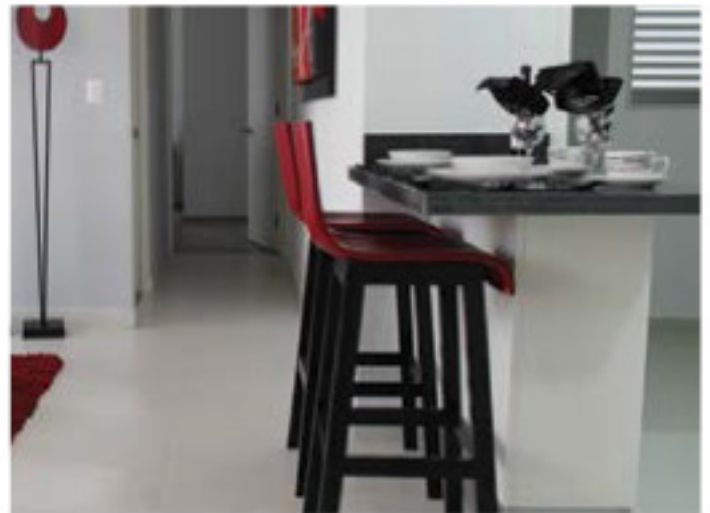
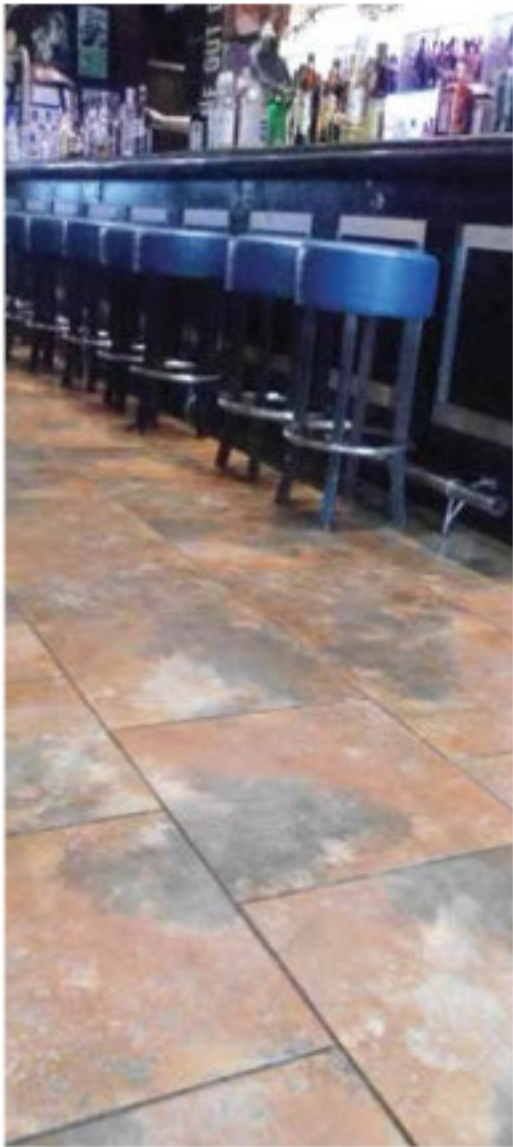

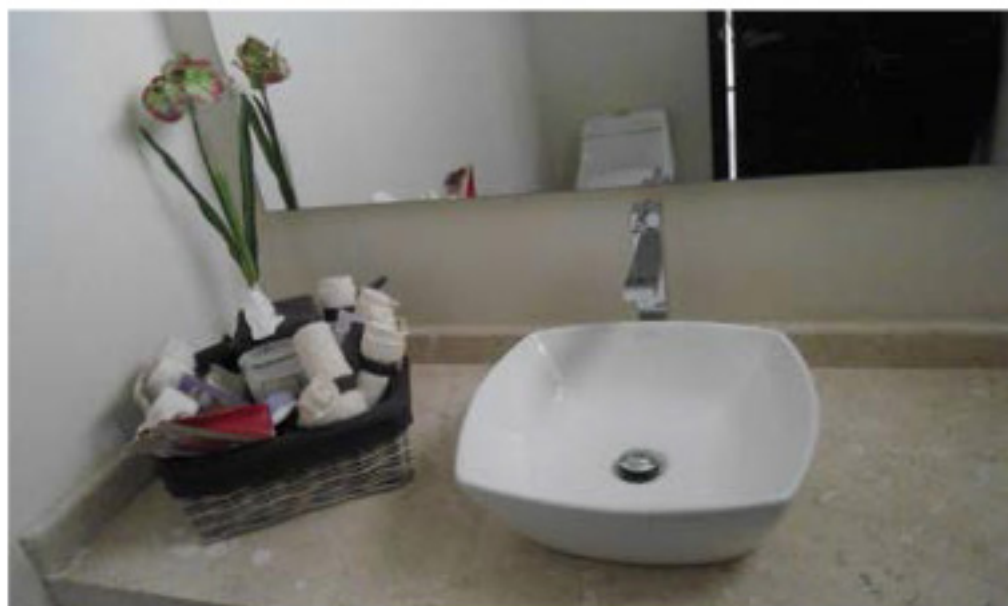

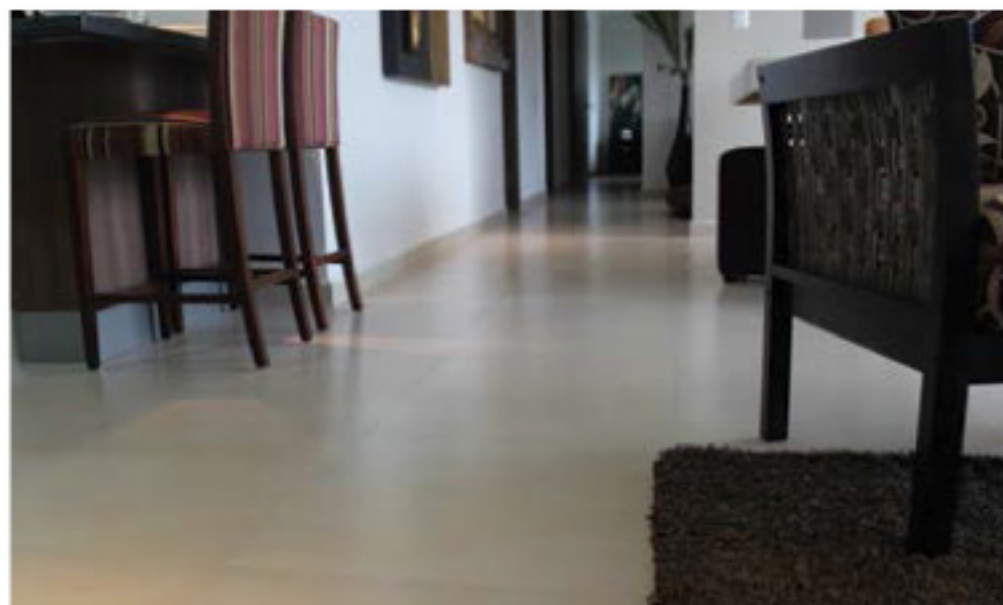
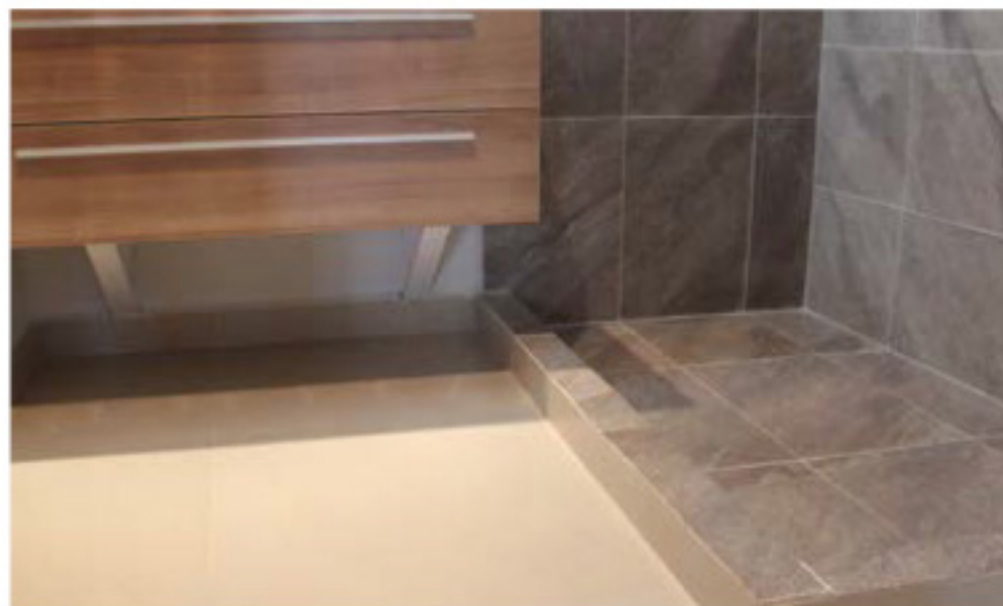
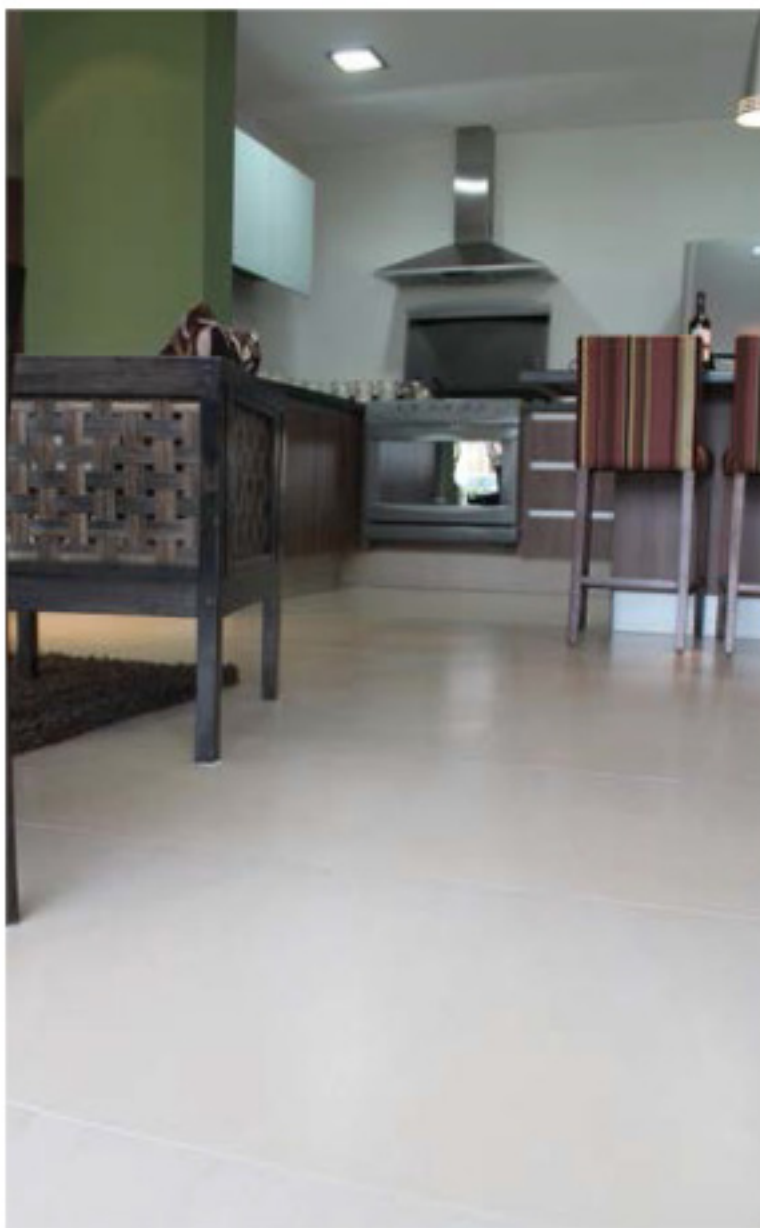



GIRECO S.A. DE C.V.
OFICINA CENTRAL
Av. Central No. 283
Col. Nueva Industrial Vallejo
C.P. 07700, México, D.F.
Tels.: 55 86 05 58 / 55 86 05 19
Fax: 55 86 16 80

OFICINA ZONA OCCIDENTE
Privada 22 No. 2727
Col. Industrial, C.P. 44940
Guadalajara, Jal.
Tels.: (0133)31 45 32 10

www.gireco.com.mx
01800 7 GIRECO

OFICINA ZONA NORTE
Jaime Nunó No. 420
Col. del Norte, C.P. 64500
Monterrey, N.L.
Tels.: (0181)83 47 45 75