

COLECCIONES 2020

Catálogo '20  
General  
EDICIÓN MÉXICO

*intermateX*  
GRUPO



## QUIENES SOMOS

**intermatex**  
GRUPO



**INTERMATEX** Grupo es el resultado actual de un esfuerzo conjunto que se inició en 1988 cuando Fidel Gil y Virginia Miralles fundaron la empresa matriz Matex Spain. Desde entonces, dentro de un proceso de adaptación continua al mercado y una evolución constante en innovación y desarrollo de producto, se han ido perfilando las líneas que hoy en día identifican a Intermatex Grupo:

Mosaico decorativo, incluyendo una amplia diversidad de materiales y de formatos,

Porcelánico, principalmente rectificado, tanto esmaltado como técnico en una gran variedad de formatos desde 30x30 hasta 60x120 cms, pasando por Slim de 6 mm en 1,2 x 2,4 mts

Y, por último, piedra natural, la última familia en incorporarse al catálogo de Intermatex.

Tras afrontar los retos que la economía global ha planteado estos últimos 15 años, la empresa hoy en día es más eficiente, optimizada y con una gobernanza más solidaria e implicada en los diferentes procesos de la actividad ordinaria de la empresa y, lo más importante, plantea su crecimiento desde una posición más sólida.

Dentro de este entorno tan competitivo, Intermatex ha tomado una importante decisión estructural que asegura el mantenimiento de sus políticas de expansión, y tras dos años de planificación, el pasado 5 de abril de 2019 se han inaugurado las nuevas instalaciones en el polígono industrial 'El Colador' de Onda, en Castellón (España).

Un movimiento estratégico que era vital para dar una continuidad sostenible al crecimiento de la empresa que permitiese seguir ofreciendo el mejor servicio a sus clientes. La nueva sede de la compañía implica una gran mejora en cuanto al espacio, principal restricción al crecimiento en sus antiguas instalaciones de Villarreal.

Esta nueva ubicación incluye:

Casi 1.000m<sup>2</sup> de oficinas, que permiten una mejor y más funcional organización de los departamentos,

Más de 8.500m<sup>2</sup> de almacén cubierto, indispensables para mantener el 100% de las mercaderías en un perfecto estado para su venta,

Y una zona de carga de aproximadamente 4.000 m<sup>2</sup> con doble muelle fijo, imprescindibles, por un lado, para optimizar la velocidad de las cargas de camión abierto y, por otro, dotar de agilidad las cargas de contenedor.

De esta forma Intermatex deja atrás, en Villarreal, 15 años de un gran progreso, crecimiento, evolución y madurez, que se perciben en la propia organización de la empresa, en sus estándares, en su visión y misión y que más tangiblemente puede observarse en su catálogo y en su penetración de mercado.

Fruto de esta evolución y crecimiento es Intermatex USA LLC, nuestra filial en EEUU, con 5 años de antigüedad. Establecida en Savannah, en el estado de Georgia, para, con la misma visión que su empresa matriz en España, dar el mejor servicio al cliente norteamericano, con un producto decorativo suficientemente diferenciado, pero atractivo y vendible en el día a día. Esta progresión operativa está permitiendo crecimientos importantes y que están acelerando los planes de un mayor establecimiento en el país.

Agradecemos genuinamente a todos nuestros clientes y colaboradores la fidelidad y apoyo que a lo largo de estos años nos han mostrado y les invitamos a que participen con nosotros de los retos que tenemos por delante.

# Índice

## DECORADOS



Chess .....	4
Dama .....	5
Mystic .....	6
Natura .....	7

## FACHADAS



Rock .....	8
------------	---

## REVESTIMIENTO



Denver .....	9
Nepal .....	10

## MOSAICO



America .....	11
Carnaval .....	12
Elements .....	14
Emoji .....	15
Infinity .....	16
Kaos .....	17
Keops .....	18
Myka .....	19
Tailor .....	20
Time .....	21
Picnic .....	22
Vanity .....	22
Prisma .....	23
Unique .....	24
River .....	25
HOME .....	26
Spa .....	27
Tech Chevron .....	28
Tech Octogon .....	29
Tech Flame .....	30
Tech York .....	31
Tech Ibiza .....	32
Tech Tokio .....	33
Tech Harmonie .....	34
Hydra .....	35
Jewel .....	36

## PORCELÁNICO



Sandy .....	37
Concrete .....	39
Domus .....	40
Etna .....	41
Gramercy .....	43
Manhattan .....	45

## PORCELÁNICO (MESONES)



Mesones .....	47
Jumilla .....	47
Menorca .....	47
Triana .....	47
Kenia .....	49
Tarifa .....	49
Canarias .....	49
Salpicaderos .....	47
Jumilla .....	47
Menorca .....	47
Triana .....	47
Kenia .....	49
Tarifa .....	49
Canarias .....	49

## CUARZO (MESONES)



Mesones .....	51
Cuarzo Negro .....	51
Cuarzo Rojo .....	51
Cuarzo Blanco .....	51
Salpicaderos .....	51
Cuarzo Negro .....	51
Cuarzo Rojo .....	51
Cuarzo Blanco .....	51

## PELDAÑOS



Peldaños .....	53
----------------	----

## PORCELANA SANITARIA



Lavamanos .....	56
-----------------	----

## ALUMINIO



Perfiles Aluminio .....	55
-------------------------	----

## ACCESORIOS



Accesorios de baño Plus .....	57
-------------------------------	----





# Chess

Decorados

15 x 45 cm



Chess Aroma\*

15 x 45 cm



Chess Fragancia\*

15 x 45 cm

\* 8 variantes de diseño



Chess	Pcs/Caja	m <sup>2</sup> /Caja	Peso/Caja (Kg)	Caja/Palet	m <sup>2</sup> /Palet	Peso/Palet (Kg)
	15	1,012	16,95	66	66,792	1119

15 x 45 cm



DAMA MÁRMOL



DAMA MULTICOLOR



Dama Mármol

15 x 45 cm



Dama Multicolor

15 x 45 cm



Dama Terracota

15 x 45 cm



REVESTIMIENTO BRILLO DESTONIFICADO RELIEVE ESMALTADO CERAMICA IMPRESION DIGITAL

Dama	Pcs/Caja	m <sup>2</sup> /Caja	Peso/Caja (Kg)	Caja/Palet	m <sup>2</sup> /Palet	Peso/Palet (Kg)
	15	1,012	18,10	66	66,792	1195



# Mystic

Decorados

30 x 30 cm



MYSTIC BLACK

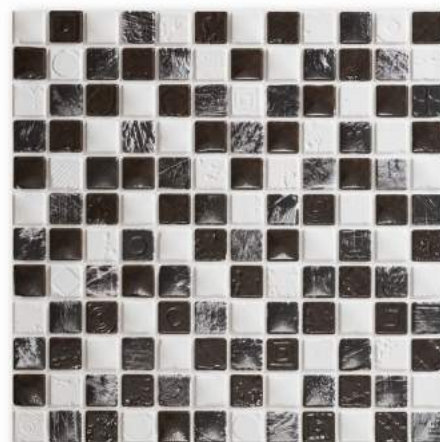

Mystic Black

30 x 30 cm



Mystic Beige

30 x 30 cm

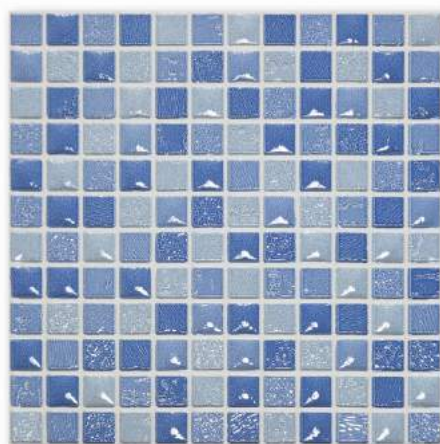

Mystic Blue

30 x 30 cm

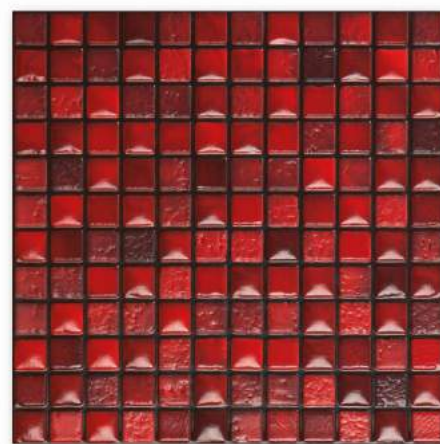

Mystic Red

30 x 30 cm



REVESTIMIENTO

BRILLO

DESTONIFICADO

MÓDULO ENMILADO

MAFMCOL

VIDRIO

IMPRESIÓN DIGITAL

Mystic	Pzs/Caja	m <sup>2</sup> /Caja	Peso/Caja (Kg)	Caja/Palet	m <sup>2</sup> /Palet	Peso/Palet (Kg)
	12	1,080	20,50	63	68,04	1327



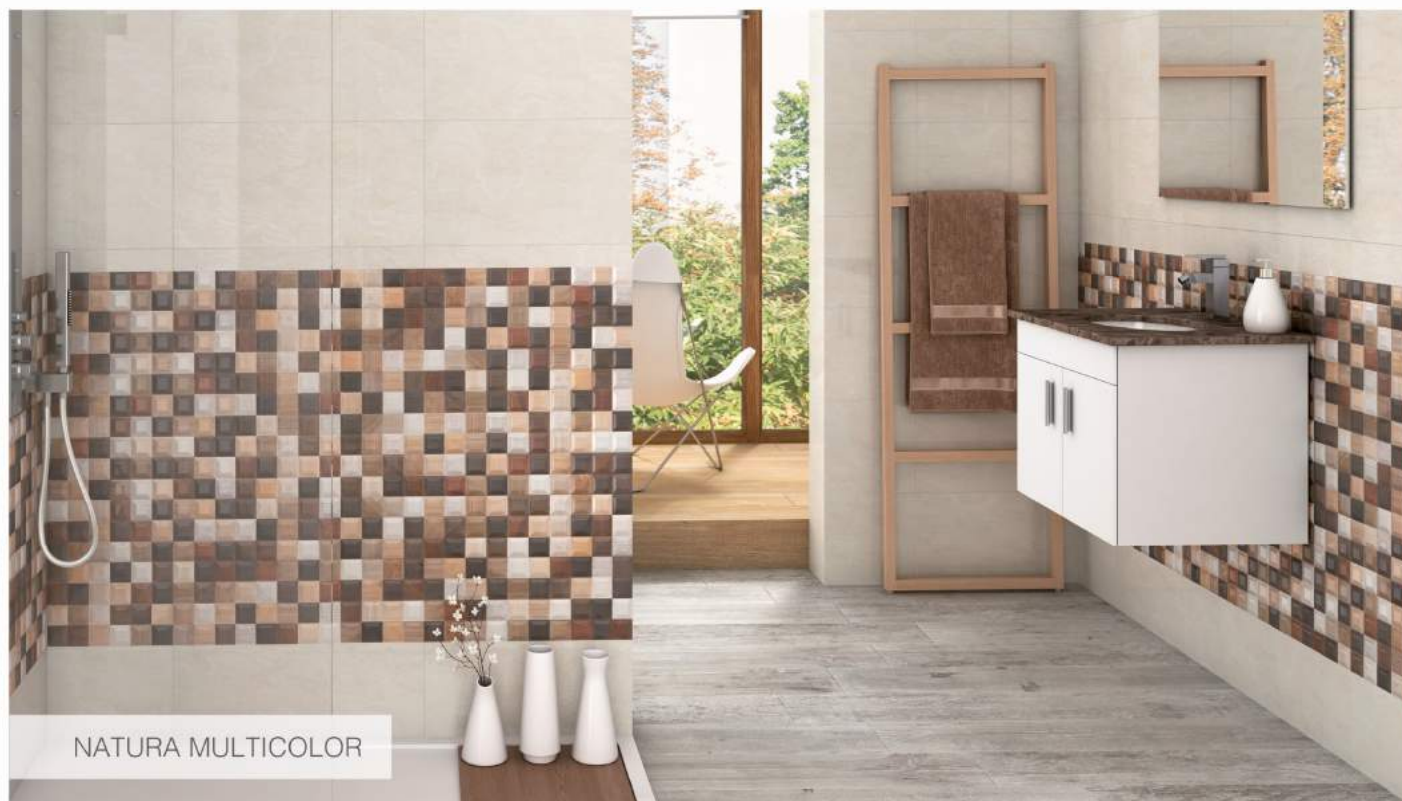

NATURA MULTICOLOR



Natura Multicolor

15 x 45 cm



Natura	Pcs/Caja	m <sup>2</sup> /Caja	Peso/Caja (Kg)	Caja/Palet	m <sup>2</sup> /Palet	Peso/Palet (Kg)
	15	1,012	16,95	66	66,792	1119

# Rock

Fachada

20 x 60 cm



Rock Gris 20 x 60 cm



Rock Rainbow 20 x 60 cm



Rock Crema 20 x 60 cm



Rock Multi 20 x 60 cm



Rock	Pzs/Caja	m <sup>2</sup> /Caja	Peso/Caja (Kg)	Caja/Palet	m <sup>2</sup> /Palet	Peso/Palet (Kg)
	7	0,84	15,8	64	53,76	1027



# Revestimiento pasta blanca

# Denver

25 x 60 cm



DENVER LINK ARENA



Denver Link Arena

25 x 60 cm



Denver Link Gris

25 x 60 cm



Denver	Pcs/Caja	m <sup>2</sup> /Caja	Peso/Caja (Kg)	Caja/Palet	m <sup>2</sup> /Palet	Peso/Palet (Kg)
	7	1,050	18,55	72	73,050	1351



# Nepal

Revestimiento pasta blanca

33 x 100 cm / 25 x 60 cm



NEPAL BLANCO BRILLO  
NEPAL SURF BLANCO BRILLO

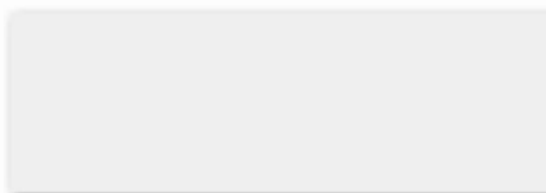

Nepal Blanco Brillo 33 x 100 cm



Nepal Link Blanco Mate  
25 x 60 cm



Nepal Surf Blanco Brillo 33 x 100 cm

## Nepal



## Nepal Surf



## Nepal Link



Nepal	Pcs/Caja	m <sup>2</sup> /Caja	Peso/Caja (Kg)	Caja/Palet	m <sup>2</sup> /Palet	Peso/Palet (Kg)
33x100 cm	4	1,330	25,00	48	63,84	1215
25x60 cm	7	1,050	13,90	72	73,050	1016

# Mosaicos

# America

30 x 30 cm



AMERICA CORINTO

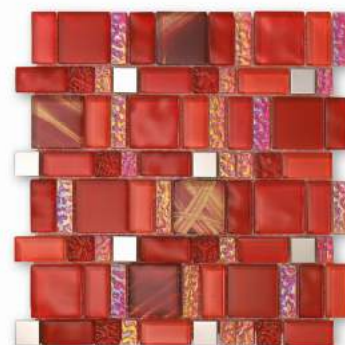

America Corinto 30 x 30 cm



America Brown 30 x 30 cm



America Grey 30 x 30 cm

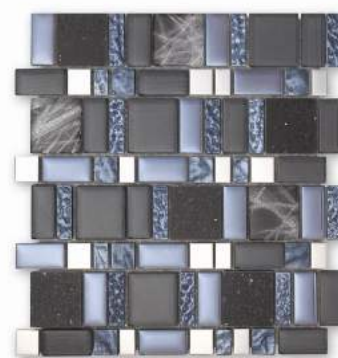

America Black 30 x 30 cm

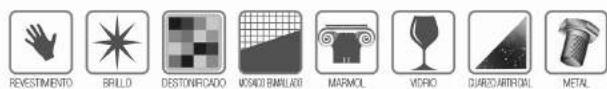

America	Pcs/Caja	m <sup>2</sup> /Caja	Peso/Caja (Kg)	Caja/Palet	m <sup>2</sup> /Palet	Peso/Palet (Kg)
	12	1,080	18,91	63	68,04	1191

# Carnaval

Mosaicos

30 x 30 cm



CARNAVAL BLUE



Carnaval Blue 30 x 30 cm

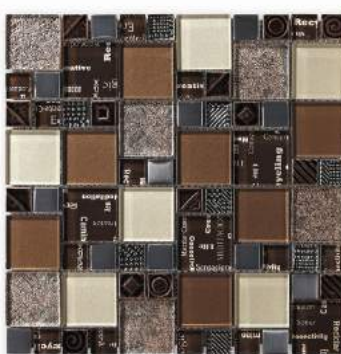

Carnaval Brown 30 x 30 cm



Carnaval Silver 30 x 30 cm



Carnaval	Pcs/Caja	m <sup>2</sup> /Caja	Peso/Caja (Kg)	Caja/Palet	m <sup>2</sup> /Palet	Peso/Palet (Kg)
	12	1,080	19,78	63	68,04	1246



30 x 30 cm

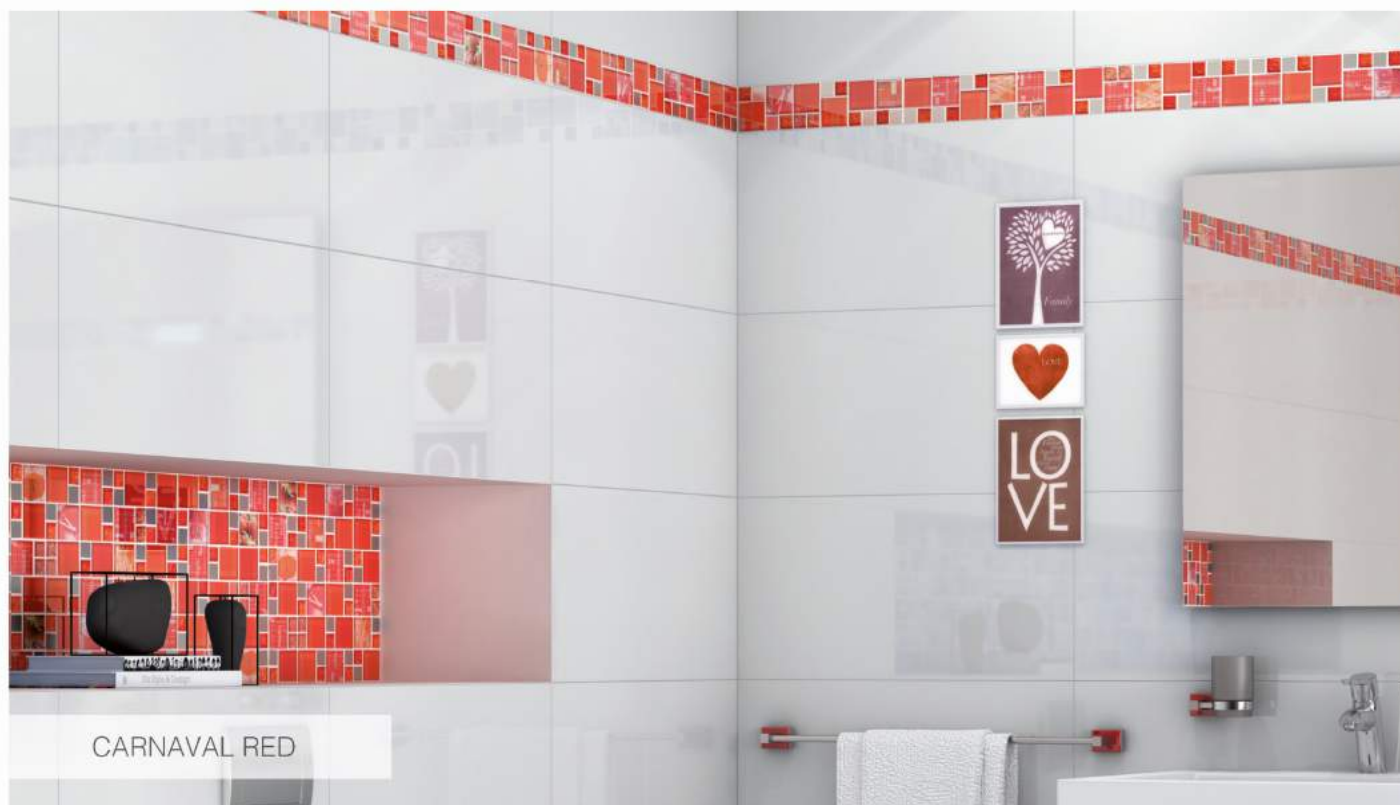

CARNAVAL RED



Carnaval Orange 30 x 30 cm



Carnaval Red 30 x 30 cm



Carnaval	Pcs/Caja	m <sup>2</sup> /Caja	Peso/Caja (Kg)	Caja/Palet	m <sup>2</sup> /Palet	Peso/Palet (Kg)
	12	1,080	19,78	63	68,04	1246

# Elements

Mosaicos

30 x 30 cm



ELEMENTS GREY



Elements Beige 30 x 30 cm



Elements Grey 30 x 30 cm



Elements Black 30 x 30 cm



Elements	Pcs/Caja	m <sup>2</sup> /Caja	Peso/Caja (Kg)	Caja/Palet	m <sup>2</sup> /Palet	Peso/Palet (Kg)
	12	1,080	20,79	63	68,04	1310



# Mosaicos

# Emoji

30 x 30 cm



EMOJI BATHROOM



EMOJI KITCHEN



Emoji Bathroom 30 x 30 cm



Emoji Kitchen 30 x 30 cm



Emoji	Pcs/Caja	m <sup>2</sup> /Caja	Peso/Caja (Kg)	Caja/Palet	m <sup>2</sup> /Palet	Peso/Palet (Kg)
	12	1,080	20,00	63	68,04	1295



# Infinity

## Mosaicos

30 x 30 cm



INFINITY BLACK



INFINITY BROWN



Infinity Black 30 x 30 cm



Infinity Brown 30 x 30 cm



Infinity Grey 30 x 30 cm



Infinity	Pcs/Caja	m <sup>2</sup> /Caja	Peso/Caja (Kg)	Caja/Palet	m <sup>2</sup> /Palet	Peso/Palet (Kg)
	12	1,080	20,10	63	68,04	1301

30 x 30 cm



KAOS FROZEN



Kaos Grey 30 x 30 cm



Kaos Frozen 30 x 30 cm



Kaos Silver 30 x 30 cm



Kaos	Pzs/Caja	m <sup>2</sup> /Caja	Peso/Caja (Kg)	Caja/Palet	m <sup>2</sup> /Palet	Peso/Palet(Kg)
Grey	12	1,080	20,29	63	68,04	1278
Frozen	12	1,080	16,46	63	68,04	1037
Silver	12	1,080	16,46	63	68,04	1037



# Keops

Mosaicos

30 x 30 cm



KEOPS GRIS



Keops Blanco 30 x 30 cm



Keops Gris 30 x 30 cm



Keops	Pzs/Caja	Pcs/Box	m <sup>2</sup> /Caja	m <sup>2</sup> /Box	Peso/Caja	Caja/Palet	m <sup>2</sup> /Palet	m <sup>2</sup> /Pallet	Peso/Palet
									Weight/Pallet
	12		1,080		20,50	63	68,04		1327



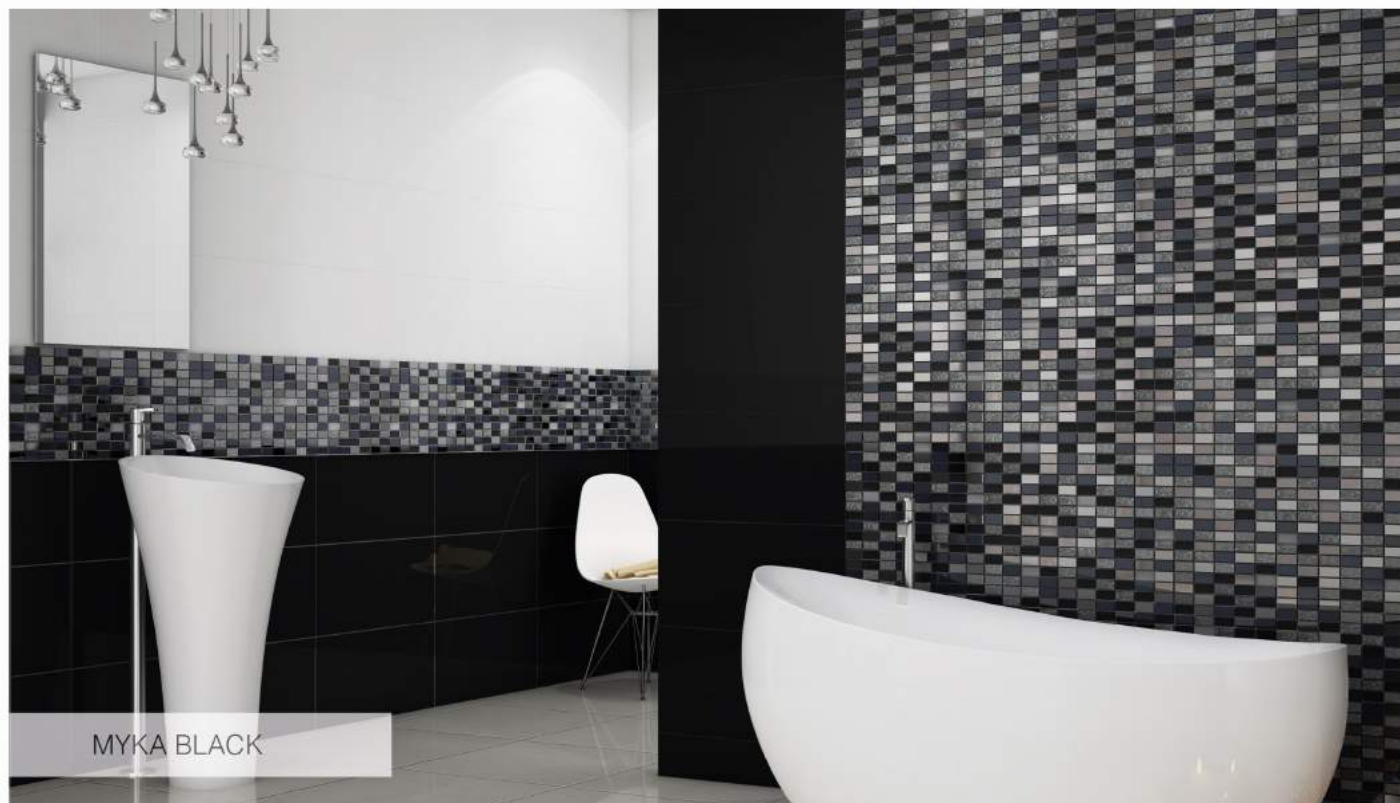

Myka Beige 30 x 30 cm



Myka Black 30 x 30 cm



Myka	Pcs/Caja	m <sup>2</sup> /Caja	Peso/Caja (Kg)	Caja/Palet	m <sup>2</sup> /Palet	Peso/Palet (Kg)
	12	1,080	17,96	63	68,04	1131

# Tailor

Mosaicos

30 x 30 cm



TAILOR BEIGE  
TAILOR GREY



Tailor Beige

30 x 30 cm

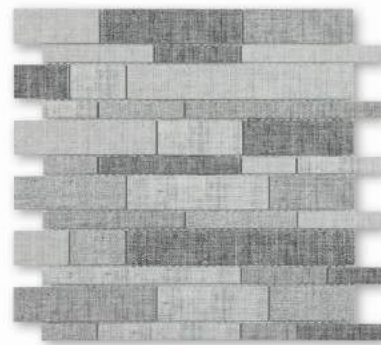

Tailor Grey

30 x 30 cm



Tailor	Pzs/Caja	m <sup>2</sup> /Caja	Peso/Caja (Kg)	Caja/Palet	m <sup>2</sup> /Palet	Peso/Palet (Kg)
	12	1,080	19,24	63	68,04	1212



# Mosaicos

# Time

30 x 30 cm



TIME SILVER



Time White

30 x 30 cm



Time Grey

30 x 30 cm



Time Silver

30 x 30 cm



REVESTIMIENTO MATE-BRILLO DESTONIFICADO USADO EN PARED VIDRIO METAL INTERIOR

Time	Pcs/Caja	m <sup>2</sup> /Caja	Peso/Caja (Kg)	Caja/Palet	m <sup>2</sup> /Palet	Peso/Palet (Kg)
	12	1,080	18,95	63	68,04	1229

# Picnic / Vanity

Mosaicos

30 x 30 cm



PICNIC MULTI



VANITY MULTI



Picnic Multi

30 x 30 cm



Vanity Multi

30 x 30 cm

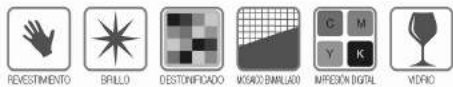

REVESTIMIENTO BRILLO DESTONIFICADO MOSAICO ENMALLADO IMPRESION DIGITAL VIDRIO

Picnic / Vanity	Pzs/Caja	m <sup>2</sup> /Caja	Peso/Caja (Kg)	Caja/Palet	m <sup>2</sup> /Palet	Peso/Palet (Kg)
	12	1,080	19,88	54	58,32	1109



30 x 30 cm



PRISMA SILVER



Prisma Silver 30 x 30 cm



Prisma	Pzs/Caja	m <sup>2</sup> /Caja	Peso/Caja (Kg)	Caja/Palet	m <sup>2</sup> /Palet	Peso/Palet (Kg)
	12	1,080	19,75	63	68,04	1279

# Unique

Mosaicos

30 x 30 cm



Unique Brown 30 x 30 cm

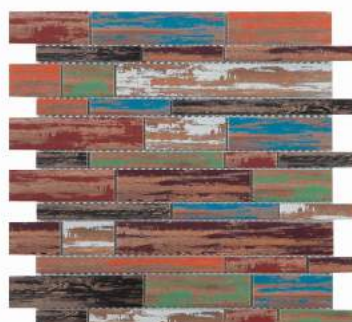

Unique Colors 30 x 30 cm



Unique	Pzs/Caja	m <sup>2</sup> /Caja	Peso/Caja (Kg)	Caja/Palet	m <sup>2</sup> /Palet	Peso/Palet (Kg)
	12	1,080	19,24	63	68,04	1212



30 x 30 cm



RIVER WHITE



Se suministra con 3 piezas adicionales en cada malla para utilizarse como acabado de remate final, sin necesidad de cortar el vidrio.



River White 30 x 30 cm



River Silver 30 x 30 cm



River	Pcs/Caja	m <sup>2</sup> /Caja	Peso/Caja (Kg)	Caja/Palet	m <sup>2</sup> /Palet	Peso/Palet (Kg)
	12	1,080	20,10	63	68,04	1301

Bajo esta marca Intermatex agrupa una tipología de mosaico vítreo con gran variedad de usos. Es válido para revestimiento y pavimento, tanto interior como exterior, además está especialmente recomendado para zonas húmedas.

32,7 x 32,7 cm



SOLO COFFEE



Solo Coffee 32,7 x 32,7 cm



Hôme	Pzs/Caja	m <sup>2</sup> /Caja	Peso/Caja (Kg)	Caja/Palet	m <sup>2</sup> /Palet	Peso/Palet (Kg)
	10	1,069	7,70	180	192,42	1386





SPA BLUE

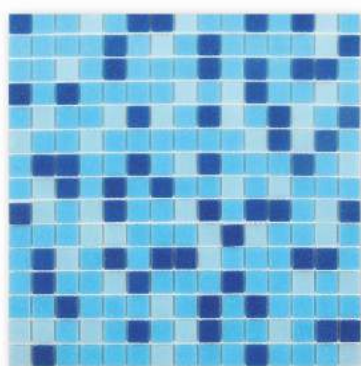

Spa Blue 30 x 30 cm



Spa Blue	Pzs/Caja	m <sup>2</sup> /Caja	Peso/Caja (Kg)	Caja/Palet	m <sup>2</sup> /Palet	Peso/Palet (Kg)
	20	1,80	14	1800	162	1282

# Tech

## Mosaicos

28,3 x 27,7 cm



TECH CHEVRON  
WHITE GLOSS



TECH CHEVRON  
WHITE GLOSS



Tech Chevron White Gloss  
28,3x27,7 cm



Chevron	Pcs/Caja	m <sup>2</sup> /Caja	Peso/Caja (Kg)	Caja/Palet	m <sup>2</sup> /Palet	Peso/Palet (Kg)
	10	0,784	9,10	108	84,672	1018



29,4 x 29,4 cm



TECH OCTOGON  
WHITE MATT

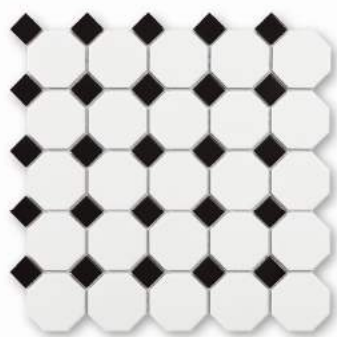

Tech Octogon White Matt  
29,4x29,4 cm



Octogon	Pcs/Caja	m <sup>2</sup> /Caja	Peso/Caja (Kg)	Caja/Palet	m <sup>2</sup> /Palet	Peso/Palet (Kg)
	10	0,870	10,30	108	93,96	1147

# Tech

## Mosaicos

28 x 24,6 cm



Tech Flame White Gloss  
28x24,6 cm



Flame	Pcs/Caja	m <sup>2</sup> /Caja	Peso/Caja (Kg)	Caja/Palet	m <sup>2</sup> /Palet	Peso/Palet (Kg)
	10	0,689	8,20	108	74,412	921



26,5 x 30,9 cm



TECH YORK  
WHITE GLOSS



Tech York White Gloss  
26,5x30,9 cm



Tech York Blend Gloss  
26,5x30,9 cm



York	Pcs/Caja	m <sup>2</sup> /Caja	Peso/Caja (Kg)	Caja/Palet	m <sup>2</sup> /Palet	Peso/Palet (Kg)
	10	0,819	11,70	108	88,452	1299

# Tech

## Mosaicos

26 x 30 cm

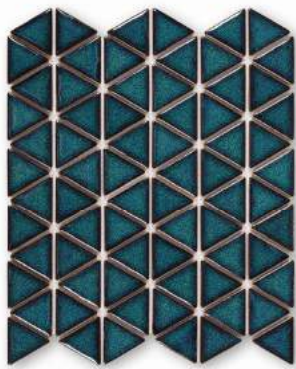

Tech Ibiza Teal 26x30 cm



Tech Ibiza White 26x30 cm

\*Debido a los esmaltes reactivos/craquelados utilizados en este artículo su aspecto final puede diferir ligeramente de esta muestra/fotografía.



Ibiza	Pcs/Caja	m <sup>2</sup> /Caja	Peso/Caja (Kg)	Caja/Palet	m <sup>2</sup> /Palet	Peso/Palet (Kg)
	10	0,900	8,80	99	89,10	906



29 x 30 cm



TOKIO WHITE

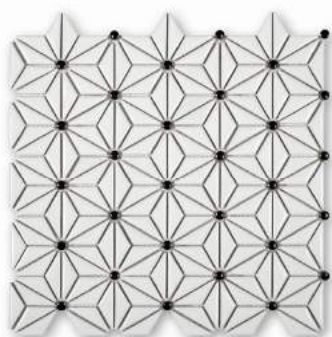

Tech Tokyo White 29x30 cm

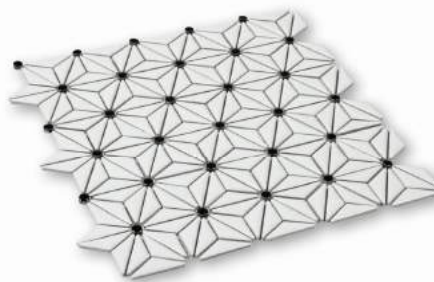

\* Transito moderado.

Tokyo	Pcs/Caja	m <sup>2</sup> /Caja	Peso/Caja (Kg)	Caja/Palet	m <sup>2</sup> /Palet	Peso/Palet (Kg)
	10	0,870	7,77	99	86,13	804

11,5 x 20



Harmonie Blanc Matt 11,5x20 cm

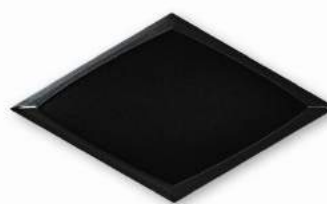

Harmonie Noir Matt 11,5x20 cm



Harmonie	Pcs/Caja	m <sup>2</sup> /Caja	Peso/Caja (Kg)	Caja/Palet	m <sup>2</sup> /Palet	Peso/Palet (Kg)
	48	0,554	11,44	63	34,90	756



30 x 30 cm



Hydra Beige 30x30 cm



Hydra	* Mármol					
	Pcs/Caja	m <sup>2</sup> /Caja	Peso/Caja (Kg)	Caja/Palet	m <sup>2</sup> /Palet	Peso/Palet (Kg)
	12	1,080	18,28	63	68,04	1187

# Jewel

## Mosaicos

28,6 x 31 cm



JEWEL CREAM

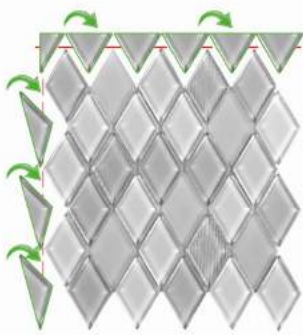

\*Se suministra con piezas adicionales en dos lados de cada malla para utilizarse como acabado de remate final, sin necesidad de cortar el vidrio.



Jewel Cream

28,6 x 31 cm



Jewel	Pcs/Caja	m <sup>2</sup> /Caja	Peso/Caja (Kg)	Caja/Palet	m <sup>2</sup> /Palet	Peso/Palet (Kg)
	12	0,830	17,40	63	52,29	1131





Sandy Grey

60 x 120 cm



Sandy Grey

60 x 120 cm



Sandy	Pcs/Caja	m <sup>2</sup> /Caja	Peso/Caja (Kg)	Caja/Palet	m <sup>2</sup> /Palet	Peso/Palet (Kg)
	2	1,440	34,62	25	36	901



CONCRETE GREY



60 x 120 cm



Concrete Beige

60 x 120 cm



Concrete Grey

60 x 120 cm



Concrete Nero

60 x 120 cm

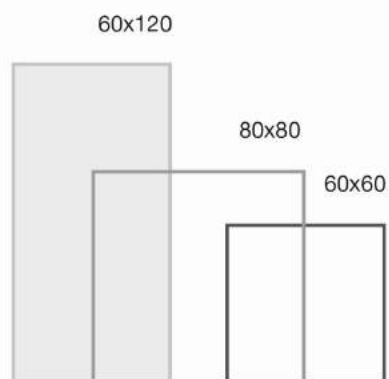

Concrete	Pcs/Caja	m <sup>2</sup> /Caja	Peso/Caja (Kg)	Caja/Palet	m <sup>2</sup> /Palet	Peso/Palet (Kg)
60x120	2	1,440	34,40	25	36	895
80x80	3	1,920	43,60	44	84,48	1953
60x60	4	1,440	27,32	36	51,84	1019



# Domus

Porcelánicos

60 x 120 cm



DOMUS BIANCO



Domus Bianco

60 x 120 cm  
(6 GRÁFICAS DIFERENTES)



Domus	Pcs/Caja	m <sup>2</sup> /Caja	Peso/Caja (Kg)	Caja/Palet	m <sup>2</sup> /Palet	Peso/Palet (Kg)
	2	1,440	33,65	28	40,32	977



60 x 120 cm

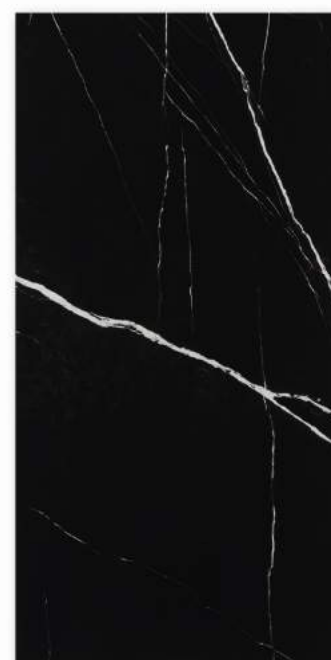

Etna 60 x 120 cm

ETNA



Etna	Pzs/Caja	m <sup>2</sup> /Caja	Peso/Caja (Kg)	Caja/Palet	m <sup>2</sup> /Palet	Peso/Palet (Kg)
	2	1,440	30,55	30	43,20	952



GRAMERCY BEIGE



20 x 120 cm



Gramercy White 20 x 120 cm  
(9 GRÁFICAS DIFERENTES)



Gramercy Beige 20 x 120 cm  
(9 GRÁFICAS DIFERENTES)



Gramercy Brown 20 x 120 cm  
(9 GRÁFICAS DIFERENTES)



Gramercy	Pcs/Caja	m <sup>2</sup> /Caja	Peso/Caja (Kg)	Caja/Palet	m <sup>2</sup> /Palet	Peso/Palet (Kg)
	5	1,200	27,50	39	46,8	1073



MANHATTAN SUMMER



Porcelánicos

# Manhattan

20 x 120 cm



Manhattan Summer

20 x 120 cm  
(15 GRÁFICAS DIFERENTES)



Manhattan	Pcs/Caja	m <sup>2</sup> /Caja	Peso/Caja (Kg)	Caja/Palet	m <sup>2</sup> /Palet	Peso/Palet (Kg)
	5	1,200	27,50	39	46,8	1073



MESON JUMILLA



MESON MENORCA



Porcelánicos

# Mesones

60 x 120 cm



Salpicadero Jumilla 9,6 x 120 cm  
Mesón Jumilla 60 x 120 cm



Salpicadero Menorca 9,6 x 120 cm  
Mesón Menorca 60 x 120 cm



Salpicadero Triana 9,6 x 120 cm  
Mesón Triana 60 x 120 cm



Mesones Porcelánicos	Pzs/Caja	m <sup>2</sup> /Caja	Peso/Caja (Kg)	Caja/Palet	m <sup>2</sup> /Palet	Peso/Palet (Kg)
	2	1,440	42,65	28	69,12	2047





MESON KENYA



Porcelánicos

# Mesones

60 x 120 cm

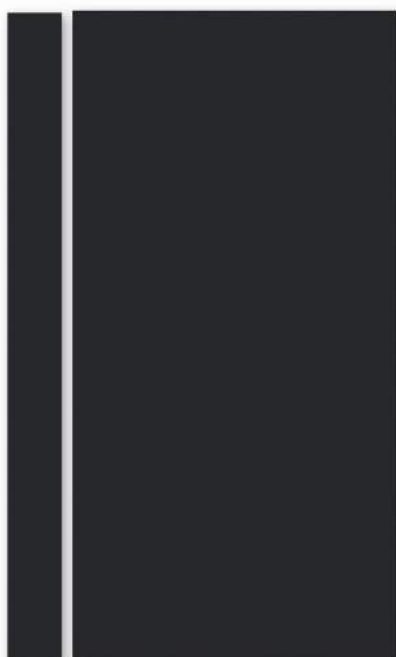

Salpicadero Kenya 9,6 x 120 cm  
Mesón Kenya 60 x 120 cm



Salpicadero Tarifa 9,6 x 120 cm  
Mesón Tarifa 60 x 120 cm



Salpicadero Canarias 9,6 x 120 cm  
Mesón Canarias 60 x 120 cm



Mesones Porcelánicos	Pzs/Caja	m <sup>2</sup> /Caja	Peso/Caja (Kg)	Caja/Palet	m <sup>2</sup> /Palet	Peso/Palet (Kg)
	2	1,440	42,65	28	69,12	2047



CUARZO NEGRO



60 x 140 cm



Mesón Cuarzo Negro  
60 x 140cm



Mesón Cuarzo Rojo  
60 x 140cm



Mesón Cuarzo Blanco  
60 x 140cm



Salpicadero Cuarzo Negro 9,6 x 140 cm



Salpicadero Cuarzo Rojo 9,6 x 140 cm



Salpicadero Cuarzo Blanco 9,6 x 140 cm



Mesones Cuarzo	Pzs/Caja	m <sup>2</sup> /Caja	Peso/Caja (Kg)	Caja/Palet	m <sup>2</sup> /Palet	Peso/Palet (Kg)
	2	1,680	47,00	23	42	1175

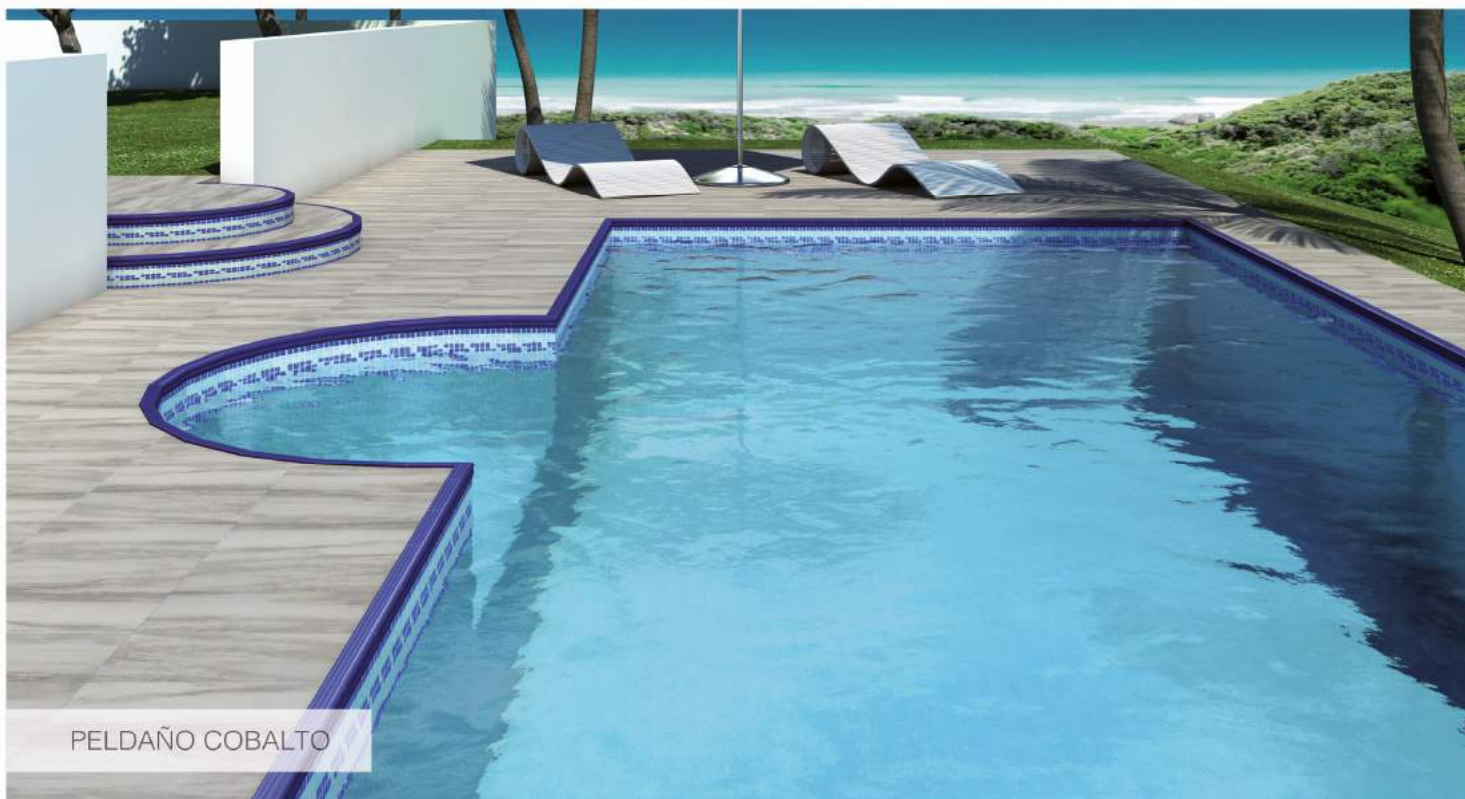

PELDAÑO COBALTO



PELDAÑO MARFIL



# Peldaños

6,5 x 5,5 x 33,5 cm



Blanco Brillo 6,5 x 5,5 x 33,5 cm



Beige Mate 6,5 x 5,5 x 33,5 cm



Marrón Brillo 6,5 x 5,5 x 33,5 cm



Gris Mate 6,5 x 5,5 x 33,5 cm



Azul Cobalto Satinado 6,5 x 5,5 x 33,5 cm



Madera Grey 6,5 x 5,5 x 33,5 cm



Madera Fresno 6,5 x 5,5 x 33,5 cm



Madera Nogal 6,5 x 5,5 x 33,5 cm



Madera Cerezo 6,5 x 5,5 x 33,5 cm



Peldaños	Pzs/Caja	m <sup>2</sup> /Caja	Peso/Caja (Kg)	Caja/Palet	m <sup>2</sup> /Palet	Peso/Palet (Kg)
	15	0,599	12,30	72	43,128	886



PERFILES



# Perfiles Aluminio

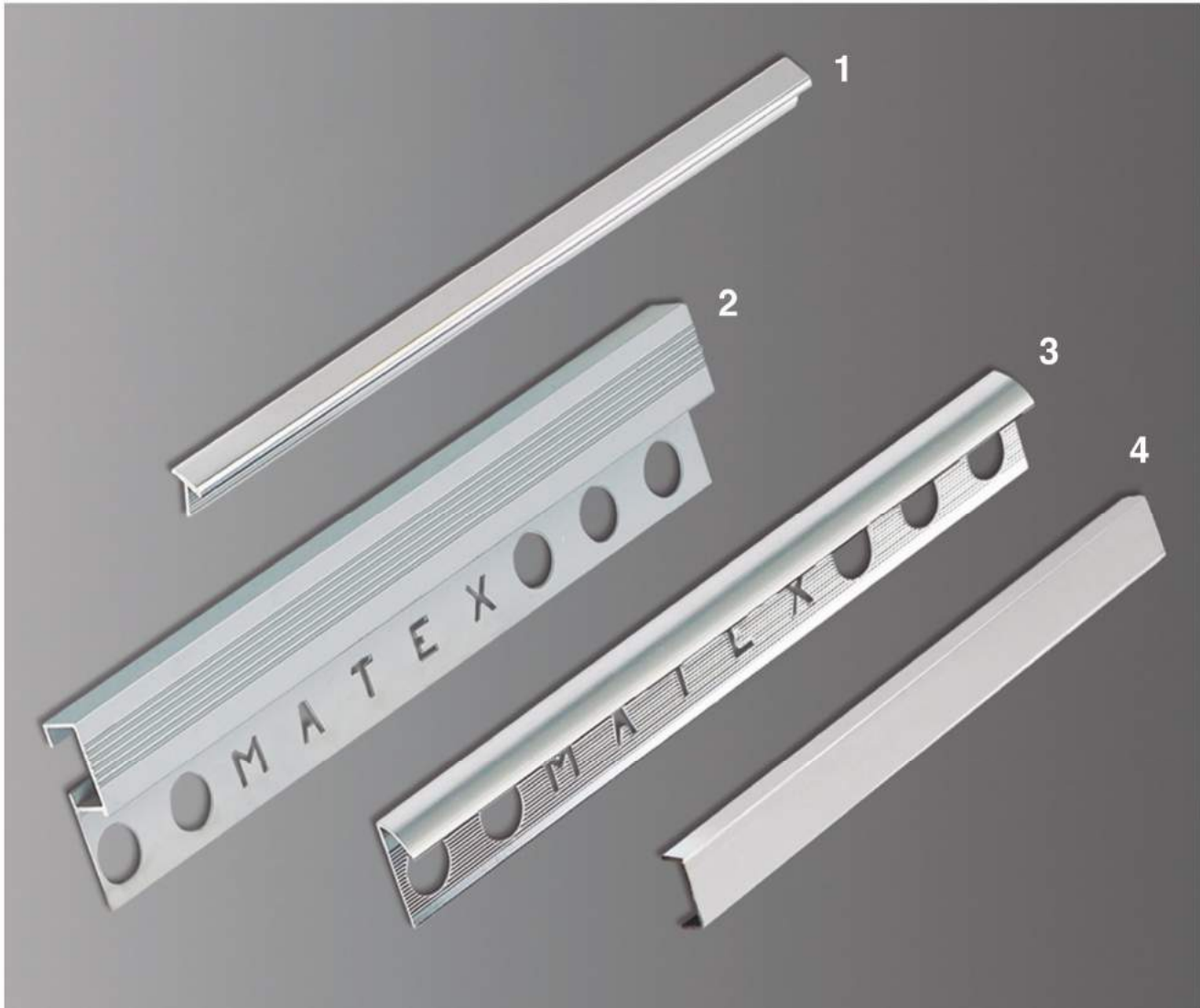

## PERFILES DE ALUMINIO 2.5 ML:

- (1) T-10 Plata Pulido
- (2) Peldaño Plata Mate
- (3) Perfil Azulejo Plata Pulido
- (4) Perfil Tipo U Plata Pulido

# Lavamanos



Caribe Carrara 60 x 46



Trópico Carrara 90 x 46



Caribe Imperial 60 x 46



Trópico Imperial 90 x 46



Caribe Marfil 60 x 46

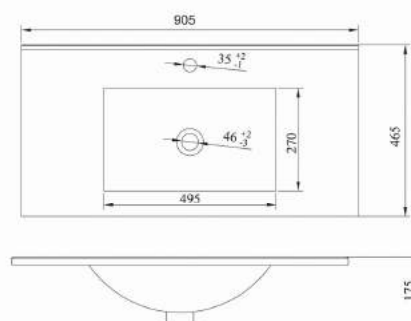
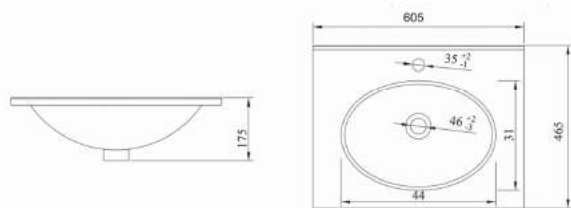



# Plus



Plus  
Acc. portavasos



Plus  
Acc. toallero aro



Plus  
Acc. portarrollos



Plus  
Acc. percha doble



Plus  
Acc. portaplato



Plus  
Acc. toallero barra



Plus  
Acc. Jabón ducha

\* No incluido en caja.  
Se vende separado.

DECORADOS

FACHADA

REVESTIMIENTO

MOSAICOS

PORCELÁNICO

PORCELÁNICO  
(MESONES)

CUARZO

PELDAÑOS

ALUMINIO

PORCELANA  
SANTITARIA

ACCESORIOS  
DE BAÑO

# Ensayos realizados y especificaciones técnicas

ENSAYOS REALIZADOS POR



- UNE-EN-ISO 10545-2 DETERMINACIÓN DE LAS DIMENSIONES (LONGITUD y PLANITUD DE SUPERFICIE)
- UNE-EN-ISO 10545-3 DETERMINACIÓN DE LA ABSORCIÓN DE AGUA
- UNE-EN-ISO 10545-4 RESISTENCIA A LA FLEXIÓN Y CARGA DE ROTURA
- UNE-EN-ISO 10545-6 DETERMINACIÓN DE LA RESISTENCIA A LA ABRASIÓN PROFUNDA. BALDOSAS NO ESMALTADAS
- UNE 67-101-92=EN-101 DETERMINACIÓN DE LA DUREZA AL RAYADO DE LA SUPERFICIE SEGÚN MOHS.

## Especificaciones técnicas del Gres Porcelánico

Norma	Descripción	Mínimo exigido Grupo B1a	Especificación Intermatex
ISO 10545-2	Longitud y anchura	max. 0.6%	<0.1%
ISO 10545-2	Planitud de superficie	max. 0.5%	<0.1%
ISO 10545-3	Absorción de agua	max. 0.5%	<0.2%
ISO 10545-4	Resistencia a la Flexión y carga de rotura	>900N	>1100N
ISO 10545-6	Abrasión profunda	max. 175 mm <sup>3</sup>	<115 mm <sup>3</sup>
EN-101.1191	Dureza al rayado según Mohs	no exigible (Pulido) min 4-6 (Esmaltado)	MOHS 4 MOHS 5-9
UNE-ENV 12633-2003 Anexo A	Resistencia al deslizamiento (Péndulo)		A consultar según modelo
DIN 51130.2010 Apdo. 5	Determinación de ángulo crítico del deslizamiento (Rampa)		A consultar según modelo



# Información Técnica

## MOSAICO

### Preparación de la superficie:

La superficie debe estar limpia, compacta, perfectamente plana y libre de suciedad y grietas.

Hay que igualar todas las áreas irregulares de la superficie, es posible que se necesite una capa para nivelar y hacer que la superficie sea plana.

Asegúrese de que la superficie esté seca, con un máximo de 3% de humedad contenida.

No instale los mosaicos directamente sobre contrachapado o paneles de yeso

### Colocación:

Antes de iniciar la instalación inspeccione todas las mallas de mosaico y asegúrese que el material está en buenas condiciones y sin defectos. Establecer directrices mientras se alicata ayudarán a que el producto quede alineado.

El tamaño de la llana dentada depende del mosaico, cuanto más delgados los mosaicos más pequeña la llana.

Recomendamos adhesivo de alto rendimiento (especial para mosaicos y porcelánico).

Asegúrese de aplicar sólo adhesivo al área que puede chapar en 15 minutos, ya que se seca muy rápido.

Después de pegar los mosaicos, utilizar una llana de goma para presionar los mosaicos para garantizar una perfecta adhesión. Asegúrese de que la distancia entre diferentes mallas es la misma que la que existe entre las piezas en la misma malla.

Adhesivo requiere por lo menos 24 horas para secar.

Manipular los mosaicos cuidadosamente ya que contienen elementos frágiles como el vidrio, espejo, acero, aluminio, travertino, mármol, resina, porcelánico, nácar, cuarzo, etc.

### Rejuntado:

Antes de aplicar el rejunte asegúrese de que todas las piezas están perfectamente limpias y libres de residuos y polvo.

Rejunte no arenoso (no abrasivo) es el rejunte recomendado para ser utilizado para el mosaico debido a las pequeñas juntas. Evite utilizar rejunte arenoso, ya que puede rayar los algunos materiales como el vidrio, el acero inoxidable, la piedra pulida, etc

Usando una llana de goma aplicar el rejunte en los mosaicos. Aplíquelo en dirección vertical y horizontal para esparcir el rejunte. Aplique un poco de presión para asegurarse de que todas las juntas están bien rellenas.

Mientras el rejunte está todavía fresco, deslice en diagonal con el borde largo de la llana de goma para eliminar el exceso de rejunte y luego limpie con una esponja húmeda.

Productos abrasivos y alcalinos no deben ser utilizados para eliminar los residuos.

### Limpieza:

Para la limpieza se necesita: detergentes neutros o limpiacristales y un paño suave y limpio (para evitar rayar). Se recomienda aplicar un tratamiento de mármol de mosaicos de vidrio, al menos, una vez al año.

### Notas:

Todos los mosaicos están hechos a mano, por lo que pequeñas variaciones en color son habituales. Se recomienda comprobar las piezas antes de la colocación. Al cortar mosaicos con una sierra de agua, poner un azulejo o un trozo de plástico duro debajo en la bandeja de corte. Esto es necesario para evitar que el mosaico caiga dentro de la apertura de disco de corte, y así ser capaz de hacer un buen corte recto.

## COLOMBIA

[www.intermatex.net](http://www.intermatex.net)

### Bogotá:

Complejo Logístico Industrial Siberia Bodega 10 Bloque E (CLIS)  
150 metros de la glorieta vía Cota a Chía  
Cota  
Tels. 57 1 875 90 64 – 57 1 875 90 65  
[intermatexbogota@intermatex.net](mailto:intermatexbogota@intermatex.net)

### Medellín:

Carrera 50 FF # 10 Sur - 160 Guayabal  
Tels. 57 4 444 70 66  
[intermatexmedellin@intermatex.net](mailto:intermatexmedellin@intermatex.net)

### Cali:

Carrea 8 # 49 – 36 Barrio Villa Colombia  
Tel. 57 2 441 55 92  
[intermatexcali@intermatex.net](mailto:intermatexcali@intermatex.net)

### Barranquilla:

Avda. Circunvalar Carrera 15 Sur #90 B – 130 Barrio Las Granjas  
Tel. 57 5 3093065

### Bucaramanga:

Km 6 vía Giron – Bucaramanga, Carrera 13 # 70 – 207,  
Tel. 57 7 6909101

## MEXICO

[www.intermatex.mx](http://www.intermatex.mx)

### Mérida:

C/20 Número 91 G entre 15 y 17  
Colonia Chuburna Hgo. Yucatán (Mexico)  
Tels. 52-999-1956188 52-999-9814508  
Fax- 52-999-9814509  
[info@intermatex.mx](mailto:info@intermatex.mx)

### Guadalajara:

C/Universo 863 entre Hércules y El Sol  
Colonia Jardines del Bosque Guadalajara,  
Jalisco (Mexico) CP 44520  
Tel. (33) 33361156

## ECUADOR

[www.starceramicas.com.ec](http://www.starceramicas.com.ec)

### Cuenca:

Avda. España y de la Quebrada sector MILCHICHIG  
Tel. (07) 282 – 0761  
Celular 0969189928  
[jefaturacuenca@starceramicas.com.ec](mailto:jefaturacuenca@starceramicas.com.ec)

### Guayaquil:

Ciudadela Lotización Santa Adriana Solar 41 , Mz 3  
Tel. (04) 308 – 3821  
Celular 0995600188  
[jefaturaguayaquil@starceramicas.com.ec](mailto:jefaturaguayaquil@starceramicas.com.ec)

### Quito:

Pedro Guerrero Lote 81 y de las Anonas – Barrio 6 de Julio  
Tel. (02) 328 - 4408  
Celular 0995600187  
[atencionclienteuio@starceramicas.com.ec](mailto:atencionclienteuio@starceramicas.com.ec)

## PERÚ

[www.intermatex.com.pe](http://www.intermatex.com.pe)

Avda. Carlos Izaguirre 2737, Urb. Kama. S.M.P.

LIMA

LIMA (PERU)

Tel. (511) 379-4435

Celular: 994996352

[gerencia@intermatex.com.pe](mailto:gerencia@intermatex.com.pe)

## ESPAÑA

[www.intermatex.com](http://www.intermatex.com)

Pol. Ind. "El Colador". Calle Asturias, nº 8  
12200 ONDA (Castellón) - SPAIN  
Tel. +34 964 50 53 30 | Fax +34 964 53 66 10  
[info@intermatex.com](mailto:info@intermatex.com)



Impreso en Noviembre 2019





*intermatex*  
GRUPO

Pol. Ind. "El Colador". Calle Asturias, nº 8  
12200 ONDA (Castellón) - SPAIN

Tel. +34 964 50 53 30  
Fax +34 964 53 66 10  
Mail: [info@intermatex.com](mailto:info@intermatex.com)

[www.intermatex.com](http://www.intermatex.com)

